

Putnam Rolling Ladder® & Custom Service Hardware®

ROLLING LADDERS | ROLLING DOORS | INVISIDOOR®

PUTNAM
ROLLING LADDERS
EST. 1905



InvisiDoor

Classic No. 1 Ladder

"...and ourselves your servants for Jesus' sake." II Corinthians 4:5b



Custom Service Hardware®



WE BELIEVE:

- 1. That our customers must be given the best possible service.
2. That we must keep our operating costs as low as possible—to keep your savings as high as possible.
3. That our business ethics must be consistent with the faith of the owners in Jesus Christ and His Word, the Bible.
We invite you to write or call our president, Mike Allen. If what we do, does not match what we believe, we will make it right.

SHIPPING:

Merchandise most often ships via common carrier (UPS, Fedex, Speedee). Most orders are freight pre-paid and charged on invoice. Freight on orders shipping Ground from Jackson to destinations within the contiguous states will be charged a flat rate of 15% of the total sell price of the order (\$1399 minimum freight charge). Truck-line, COD, USPS shipped orders do not apply. The current quoted freight will be charged on these orders. All hardware items, in stock, are shipped within 48 hours. If not in stock our staff will notify you of the expected delivery time. Out of stock items are placed on back order or alternate items will be suggested. Shipment Tracking and Notification Supplied Via Internet and e-mail. Items over 96" length will incur an additional charge of \$60. Expedited shipping is available upon request at additional cost.

LTL SHIPMENTS:

Items over 96" in length, or fully assembled will incur an additional charge of \$90 and may need to be quoted. Most oversized orders 96" will ship via common LTL carrier. We work with a variety of LTL carriers to ensure safe transit of your product. This delivery service covers curbside delivery only. Opting to have your shipment lowered via a lift-gate or allowing the driver to carry the product to your residence/garage will incur additional fees.

BACK ORDERS:

We do our best to keep adequate supply of merchandise on hand, but we sometimes temporarily run short of an item. Freight on the back ordered items will be billed on the original order.

SHORTAGE & CONCEALED DAMAGES:

Must be reported within 48 hours of receipt.

DAMAGED SHIPMENTS:

You must note damage on the drivers log or delivery receipt, for UPS call for an inspection report. (Keep original packaging and contents for inspection) 1-800-Pick-UPS Truck Line Shipments: You must have specific damage noted on all copies of the freight bill.

RETURN MERCHANDISE AUTHORIZATION:

Returns accepted within 30 days of order placement. A 15% restock fee will be subtracted from the amount of all refunds. All returned shipments must have a Return Merchandise Authorization (RMA) before they are returned. A Prepaid Return label will be provided with each RMA. Unauthorized returns will result in a delay in processing and may be refused. Returns must be clean, in original packaging, unassembled, and in like new condition. Obsolete, discontinued, custom or clearance items cannot be returned. Original shipping is not refundable.

DROPSHIP RETURNS:

Drop-ship returns may incur restocking fees.

CREDIT

We allow up to 3 weeks to process and issue any credit once return is received and approved.

SPECIAL ORDERS/CUSTOM

Special order products and tools are non-returnable unless goods are determined to be defective under the manufacturer's warranty. Cancellation of special/custom ordered products may result in fee of no less than 50% of the custom item.

You have a knack for creating a perfect space. Sometimes that means simply replacing a broken faucet or repairing a crack in a driveway. Other times, you dream of a modern-looking bathroom, a more efficient way to organize the mess of cookware in the kitchen cabinets, or a better way of accessing the highest shelf of the bookcase or pantry.

For over 40 years, Custom Service Hardware has been helping everyone from DIY-minded homeowners to large cabinet shops realize their visions for their homes and projects. We have poured countless hours into creating the best experience for you—providing a wide variety of hardware options, a robust and comprehensive website, the most competitive pricing on the market, informative video guides, and top notch customer service. We'll not only help you find exactly what you need, but also go above and beyond to answer your questions, give you advice, and help you in any other way possible.

CSH will help you take your vision for any project and make it a reality.

Mike Allen, CSH President

ORDER INFORMATION:

Telephone toll free, 1-800-882-0009 and talk with one of our friendly, trained staff, and they will assist you in placing your order. Please use part numbers. Use our 24-hour FAX line to send your purchase order, (262) 375-7970. This will minimize your phone time and reduce communication errors. E-mail your orders to service@cshardware.com. Place your order on the web at www.cshardware.com.

Will call orders should be called in one hour before pick-up to allow adequate time to process orders.

PAYMENT TERMS AND FEES:

COD: Sorry, no C.O.D. orders are accepted. Please use Discover, MasterCard, or Visa. Credit terms: call or write our credit department (Sales of \$500.00 opening order and \$500.00 per month required for terms). CSH reserves the right to allow or terminate terms. Returned checks are subject to a \$50.00 charge and account terms may be changed to Visa/MC or cash. Sales Tax: We are required to collect sales tax on orders shipping to any state where Custom Service Hardware has Nexus unless we are provided with a valid exemption certificate. Purchases made over the Internet or by other remote means are not necessarily exempt from tax in the state where you reside. Many states require residents to pay the use tax to the state tax authorities. For more information and the appropriate forms and instructions, please visit your state's website. Hazardous material charges will be added to invoice when applicable.

WARRANTY:

All Products are Produced to Standard and Commercial Tolerances. We warranty products to be free from defects in materials and manufacturing. When we have determined that a product is defective, it will be replaced. At our discretion, credit may be issued instead of a replacement. This warranty is a warranty of replacement only. CSH does not guarantee the removal or installation of new hardware or cover any associated with either. This Warranty does not cover hardware which has been incorrectly installed, modified, tampered with, or used in any manner contrary to its inherited Purpose. No other Warranty is implied, and we will disclaim any implied warranty, including merchantability or fitness for a particular purpose. Proof of purchase is required.

LIABILITY:

The customer shall be responsible for testing and verifying the suitability of the product for intended use. The customer assumes all risk and liability. Our only obligation is to replacement or, alternatively, a credit for the cost of the product proven defective. We shall not be liable for any other damages, whether incidental, indirect, special, punitive, consequential or otherwise.

DAMAGED/DEFECTIVE PRODUCT:

In order to receive replacements or credit for damaged or defective products under our warranty replacement process, pictures of the damaged product will need to be sent at the time of delivery and/or discovery, before installation or any modifications are made to the product (i.e. trimming, staining, assembling). Failure to properly report damage, or damage reported after modifications are made, may result in zero or partial credit being offered. Damaged/defective items discovered during the installation process are subject to review, and will be covered, provided that all instructions for installation were properly followed.

DISCLAIMER PLEASE READ! PRICING INFORMATION:

Prices are subject to change without notice. We make every effort to avoid mistakes in our catalogs. However, should any errors appear, we reserve the right to correct them. In today's global economy, the price of raw material is constantly changing, which means that some of our pricing is constantly changing as well. We are always working to get the best price for you.

Delivery day maps for shipments from WI:

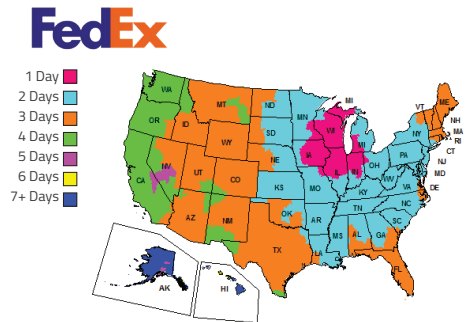
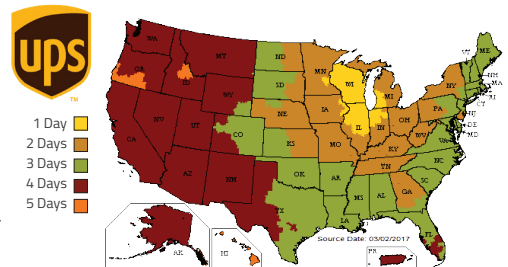

Order online at www.cshardware.com or www.putnamrollingladder.com

Call toll-free 800-882-0009 - 8 AM to 4:30 PM CST, Mon. - Fri.

Fax your order 24 Hours (262) 375-7970 or email your order at service@cshardware.com

Bifold Barn Door



Want the rolling barn door hardware “look”, but have minimal space? Look no further! Our Bifold Barn Door Hardware Kits give the pleasing aesthetic of normal barn door hardware, but use only a portion of the space! It is perfect for hallway coat closets, bedroom closets, laundry closets, pantries, and so much more. The hardware is easy to install, comes in two different mount styles and three different rail lengths to fit your desired space. There is also a double-door hardware option available in the 6-ft. rail length! Save space without sacrificing style by purchasing your Bi-Fold Barn Door Hardware Kit today.

Top Mount Style

Bifold Top Mount Single Door Hardware with Rail



Top Mount Kit with Rail Includes:

- (1) Adjustable Roller
- (1) Fixed Roller
- (1) Fixed Roller Lock Bracket
- (1) Rail
- (2) Top Connector Plates
- (1) Bottom Pivot Plate & Sleeve
- (2) Bifold Door Butt Hinges
- Rail Mount Kits
- (4 for 4-ft. or 5-ft. rails and 5 for 6-ft. rail)

Features:

- Top Mount Style
- Black Finish
- 1¾" Maximum Door Thickness
- 4-Ft. Rail Hole Distance: 16" (406mm)
- 5-Ft. Rail Hole Distance: 19-1¼" (500mm)
- 6-Ft. Rail Hole Distance: 17-2¾" (450mm)
- For a Single Bifold Door Application

SKU	Rail Length	Price
NT.BF1500.TM.08-4	Includes 4-Ft. Rail & 4 Rail Mount Kits	\$158.00
NT.BF1500.TM.08-5	Includes 5-Ft. Rail & 4 Rail Mount Kits	\$172.00
NT.BF1500.TM.08-6	Includes 6-Ft. Rail & 5 Rail Mount Kits	\$180.00

Front Mount Style

Bifold Front Mount Single Door Hardware with Rail



Top Mount Kit with Rail Includes:

- (1) Adjustable Roller
- (1) Fixed Roller
- (1) Fixed Roller Lock Bracket
- (1) Rail
- (2) Front Mount Connector Plates
- (1) Bottom Pivot Plate & Sleeve
- (2) Bifold Door Butt Hinges
- Rail Mount Kits
- (4 for 4-ft. or 5-ft. rails and 5 for 6-ft. rail)

Features:

- Front Mount Style
- Black Finish
- 1¾" Maximum Door Thickness
- 4-Ft. Rail Hole Distance: 16" (406mm)
- 5-Ft. Rail Hole Distance: 19-1¼" (500mm)
- 6-Ft. Rail Hole Distance: 17-2¾" (450mm)
- For a Single Bifold Door Application

SKU	Rail Length	Price
NT.BF1500.FM.08-4	Includes 4-Ft. Rail & 4 Rail Mount Kits	\$174.00
NT.BF1500.FM.08-5	Includes 5-Ft. Rail & 4 Rail Mount Kits	\$189.00
NT.BF1500.FM.08-6	Includes 6-Ft. Rail & 5 Rail Mount Kits	\$196.00

Bifold Top Mount Double Door Hardware with 6-Ft. Rail



Bifold Top Mount Double Door Kit with 6Ft. Rail Includes:

- (2) Adjustable Rollers
- (2) Fixed Rollers
- (2) Fixed Roller Lock Brackets
- (1) 6ft. Rail
- (4) Top Connector Plates
- (2) Bottom Pivot Plates & Sleeves
- (4) Bifold Door Butt Hinges
- (5) Rail Mount Kits

Features:

- Top Mount Style
- Black Finish
- 1¾" Maximum Door Thickness
- Rail Hole Distance: 17-2¾" (450mm)
- For a Double Bifold Door Application

SKU	Rail Length	Price
NT.BF1500.TM.08-6-2	Includes 6-Ft. Rail & 5 Rail Mount Kits	\$251.00

Bifold Front Mount Double Door Hardware with 6-Ft. Rail

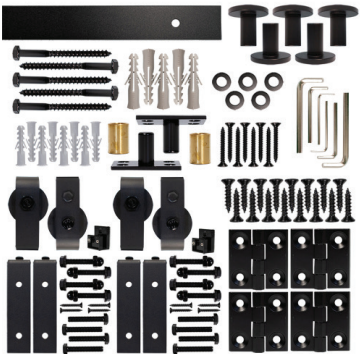

Bifold Front Mount Double Door Kit with 6ft. Rail Includes:

- (2) Adjustable Rollers
- (2) Fixed Rollers
- (2) Fixed Roller Lock Brackets
- (1) 6ft. Rail
- (4) Top Connector Plates
- (2) Bottom Pivot Plates & Sleeves
- (4) Bifold Door Butt Hinges
- (5) Rail Mount Kits

Features:

- Top Mount Style
- Black Finish
- 1¾" Maximum Door Thickness
- Rail Hole Distance: 17-2¾" (450mm)
- For a Double Bifold Door Application

SKU	Rail Length	Price
NT.BF1500.FM.08-6-2	Includes 6-Ft. Rail & 5 Rail Mount Kits	\$284.00

Rolling Barn Door Hardware

Stainless Steel Kits

Our stainless steel rolling barn door hardware kits give your home an elegant flair that will stand out from the rest. You'll be sure to fall in love with the beautiful modern look of this stainless hardware, and some models can even be used with a glass door!

Each Stainless Steel Round Rail Kit

Includes:

- 2 - Straps with Rollers
- 1 - 78³/₄" Round Rail Segment
- 2 - Rail-Mounted Door Stops
- 2 - Screw-On End Caps
- 4 - Disc Mounting Brackets
- 1 - Floor Center Guide*
- All necessary fasteners

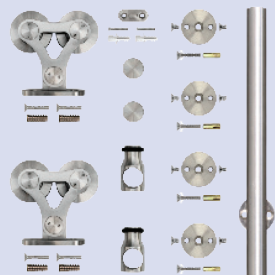

* Center guides for both wood and glass doors are included in each front mount kit.

Each Stainless Steel Flat Rail Kit

Includes:

- 2 - Straps with Rollers
- 1 - 72" or 96" Flat Rail Segment
- 2 - Flat Rail Door Stops
- 5 - Flat Rail Mounting Brackets
- 2 - Anti-Jump Blocks
- 1 - Floor Center Guide
- All necessary fasteners

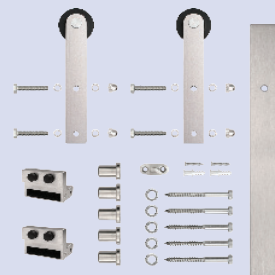

Stainless Steel Round Rail Kits:



Round Rail Kit - Top Mount

For use only with wood doors.
Max. Door Thickness: 2 5/8
Max. Weight: 200 lbs.

SKU	Rail Length	Kit
NT.1400.01WSS	78"	\$191.00
NT.1400.01W96.SS	96"	\$237.30



Round Rail Kit - Top Mount Dual Wheel

For use only with wood doors.
Max. Door Thickness: 2 5/8
Max. Weight: 220 lbs.

SKU	Rail Length	Kit
NT.1400.02WSS	78"	\$225.75
NT.1400.02W-96.SS	96"	\$245.00



Round Rail Kit - Front Mount Stick

For use with wood or glass doors.
Max. Door Thickness: 1 9/16 Wood or 12mm Glass
Max. Weight: 220 lbs.

SKU	Rail Length	Kit
NT.1400.05WG.SS	78"	\$177.45
NT.1400.05WG-96.SS	96"	\$168.00

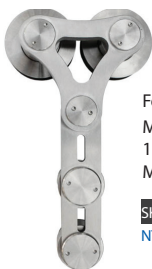

Round Rail Kit - Front Mount Dual Wheel

For use with wood or glass doors.
Max. Door Thickness: 1 9/16 Wood or 12mm Glass
Max. Weight: 240 lbs.

SKU	Rail Length	Kit
NT.1400.06WG.SS	78"	\$209.63



Round Rail Kit- Front Mount Triangle

For use with wood or glass doors.
Max. Door Thickness: 1 9/16 Wood or 12mm Glass
Max. Weight: 220 lbs.

SKU	Rail Length	Kit
NT.1400.07WG.SS	78"	\$92.41

Stainless Steel Flat Rail Kits:



Flat Rail Kit - Front Mount Stick

For use only with wood doors.
Max. Door Thickness: 1 5/8
Max. Weight: 220 lbs.

SKU	Rail Length	Kit
NT.1400.03WSS	72"	126.00

Stainless Steel Accessories:



Stainless Steel Floor Guide for Wood Doors

SKU	Finish	Each
NT.1413.SS	Stainless Steel	\$8.40



Round Rail Connector for Joining Round Rails Together

SKU	Finish	Each
NT.1405.SS	Stainless Steel	\$1155



Flat Rail Connector for Joining Flat Rails Together

SKU	Finish	Each
NT.1419.SS	Stainless Steel	\$8.40

Furniture Rolling Barn Door Hardware

Furniture Rolling Door Hardware Accessories

Soft-Close Mechanism

Love the idea of a small rolling barn door, but need to use it as a quieter application? Introducing the Soft-Close Mechanism for the Furniture Rolling Barn Door Hardware Collection! It is easy to install and is hidden behind the rail for a clean look.

Set Includes:

- 2 - Soft Close Mechanisms (L & R)
- 2 - Actuators
- All Necessary Fasteners

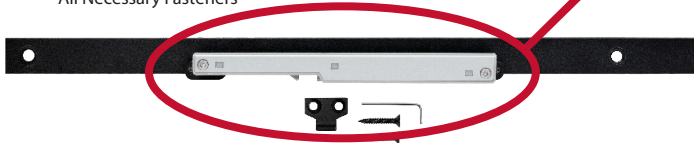

SKU	Finish	Set
NT.132.08	Black	\$21.00
NT.132.SN	Satin Nickel	\$22.05



Rail Splice Kit

Includes one connector and a set of four screws to connect two rails together.

SKU	Rail Length	Rail Height	Rail Width	Kit
NT.139.08	29/16	11/16	3/8	\$8.40
NT.139.SS	29/16	11/16	3/8	\$10.50

Optional Accessories

SKU	Product	Price
QG.1313.CH6.07	36" Plastic Channel, Requires 1/4" x 1/2" Slot in Bottom of Door	\$8.40
QG.1313.CH48.07	48" Plastic Channel, Requires 1/4" x 1/2" Slot in Bottom of Door	\$9.45
NT.1318.08	Anti-Jump Block	\$1.05
HA.404.19.118	Door Guide Bolt	\$3.95
NT.1303-34mm.08	Longer Mounting Fastener*	\$9.45

* For doors max 1 1/2" width



Plastic Channel



Anti-Jump Block



Door Guide Bolt



Longer Mounting Fastener



Furniture Rolling Door Hardware



Have a great idea for a small rolling door application for an entertainment center, storage area, or decorative piece, but think our regular barn door hardware would be a little overkill? Our mini rolling door hardware is exactly what you need! It's versatile and stylish looking, and perfect for any smaller applications you can think of.

Don't forget to buy both a strap kit and a rail kit!

Each Furniture Rolling Door Hardware Kit Includes:
 2 - Mini Straps with Rollers
 2 - Rail End Stops
 All necessary fasteners
 (Rail kits are not included but are required)



Hook, Round End
 1.00" W x 6.50" H
 NT.1310.01.08

Black Furniture Rolling Door Hardware Kit*

SKU	Strap Style	Kit
NT.1310.01.08	Hook	\$48.00
NT.1310.02.08	Wedge	\$48.00
NT.1310.03.08	Top Mount	\$48.00
NT.1310.04.08	Front Mount	\$48.00
NT.1310.05.08	Double-Diamond	\$48.00
QG.1410.06.08	Horseshoe, double wheel	\$48.00
NT.1310.08.08	Horseshoe, single wheel	\$48.00
NT.1310.09.08	Round Stick	\$48.00
NT.1310.10.08	Spade	\$48.00

*RAIL SOLD SEPARATELY

Black Furniture Barn Door Rail Kit
 Includes a steel rail (1" wide x 1/8" thick) and spacers, washers, and mounting fasteners.
 For doors 11/16" wide. **Max weight 88lbs.**

SKU	Length	# Spacers	Finish	Kit
NT.1302-48.08	48"	3	Black	\$28.00
NT.1302-60.08	60"	4	Black	\$34.00
NT.1302-72.08	72"	5	Black	\$39.00

MUST BE PURCHASED IN ADDITION TO ROLLER HARDWARE KITS

New!
 Black Bifold Furniture Rolling Door Hardware Kit

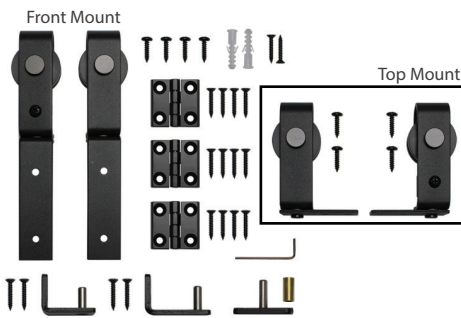

SKU	Strap Style	Kit
NT.BFM1310.FM.08	Front Mount	\$63.00
NT.BFM1310.TM.08	Top Mount	\$59.85
NT.BFM1302-48.08	48" Rail	\$37.80

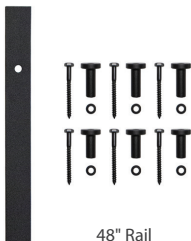

Bifold Furniture Rolling Door Hardware



Furniture Rolling Door



Don't forget to buy both a strap kit and a rail kit!



Hook, Round End
1.00" W x 6.50" H
NT.1310.0.SN

Each Furniture Rolling Door Hardware Kit Includes:
2 - Mini Straps with Rollers
2 - Rail End Stops
All necessary fasteners
(Rail kits are not included but are required)

Satin Nickel Furniture Rolling Door Hardware Kit*

SKU	Strap Style	Kit
NT.1310.01.SN	Hook	\$59.00
NT.1310.02.SN	Wedge	\$59.00
NT.1310.03.SN	Top Mount	\$59.00
NT.1310.04.SN	Front Mount	\$59.00
NT.1310.05.SN	Double-Diamond	\$59.00
NT.1310.08.SN	Horseshoe, single wheel	\$59.00
NT.1310.09.SN	Round Stick	\$59.00
NT.1310.10.SN	Spade	\$59.00

*RAIL SOLD SEPARATELY

New!

Satin Nickel Bifold Furniture Rolling Door Hardware Kit

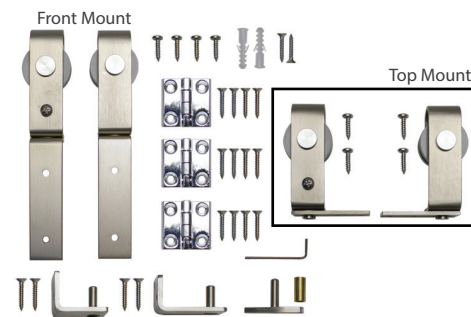

SKU	Strap Style	Kit
NT.BFM1310.M.02	Front Mount	\$77.00
NT.BFM1310.TM.02	Top Mount	\$68.25
NT.BFM1302-48.02	48" Rail	\$86.10



48" Rail

Hook, Round End
1.00" W x 6.50" H
NT.1310.01.SN

Wedge
1.25" W x 6.25" H
NT.1310.02.SN

Top Mount
3.00" W x 2.25" H
NT.1310.03.SN

Front Mount
3.00" W x 3.00" H
NT.1310.04.SN

Double Diamond
2.00" W x 6.50" H
NT.1310.05.SN



Horseshoe SW
2.12" W x 4.37" H
NT.1310.08.SN



Round Stick
1.37" W x 6.12" H
NT.1310.09.SN



Spade
1.75" W x 6.37" H
NT.1310.10.SN

Satin Nickel

Furniture Barn Door Rail Kit

Includes a steel rail (1" wide x 1/8" thick) and spacers, washers, and mounting fasteners. For doors 11/16" wide.

SKU	Length	# Spacers	Finish	Kit
NT.1302-48.SN	48"	3	Satin Nickel	\$47.00
NT.1302-60.SN	60"	4	Satin Nickel	\$55.00
NT.1302-72.SN	72"	5	Satin Nickel	\$62.00

MUST BE PURCHASED IN ADDITION TO ROLLER HARDWARE KITS



The barn doors can be opened all the way using Bifold Furniture Barn Door Hardware.

Round Rail Collection

Made in the USA!



Bring the trendy yet timeless style of our premium-quality rolling barn door hardware to your home! The Quiet Glide Round Rail is by far our most customizable collection—from tastefully rustic to simple and modern, you can create a design to suit any space.

With movable brackets for easy, universal installation and sturdy construction that supports a max recommended 250 lbs, the Quiet Glide Round Rail hardware will be a practical and stylish addition to your home!

Best-Selling Strap Styles

1 Select a Roller Strap Style

Hand-Forged, Hammered Traditional Strap



Spade



Fleur-de-Lis



Forged by a local Wisconsin blacksmith, these Spade and Fleur-de-Lis straps are custom-made exclusively for Quiet Glide. Includes fasteners and rollers.

SKU	Style	Color	Each
QG.1104.07	Spade	Oil Rubbed Bronze	\$65.10
QG.1104.08	Spade	Black	\$65.10
QG.1204.07	Fleur-de-Lis	Oil Rubbed Bronze	\$67.20
QG.1204.08	Fleur-de-Lis	Black	\$67.20

Contemporary Strap - Best Sellers

Laser-cut steel and powder-coated finish. Includes fasteners and rollers. Choose strap style and finish at right.

Round Stick

SKU	Color	Each
QG.1304.RS.02	Satin Nickel	\$27.30
QG.1304.RS.07	Oil Rubbed Bronze	\$27.30
QG.1304.RS.08	Black	\$25.20

Horseshoe

SKU	Color	Each
QG.1304.HS.02	Satin Nickel	\$40.95
QG.1304.HS.07	Oil Rubbed Bronze	\$40.95
QG.1304.HS.08	Black	\$67.20

Hook

SKU	Color	Each
QG.1304.HK02	Satin Nickel	\$33.60
QG.1304.HK07	Oil Rubbed Bronze	\$33.60
QG.1304.HK08	Black	\$32.55

Top Mount

SKU	Color	Each
QG.1304.TM.02	Satin Nickel	\$34.65
QG.1304.TM.07	Oil Rubbed Bronze	\$34.65
QG.1304.TM.08	Black	\$31.00

Basic Rectangle

SKU	Color	Each
QG.1304.BR.02	Satin Nickel	\$30.45
QG.1304.BR.07	Oil Rubbed Bronze	\$30.45
QG.1304.BR.08	Black	\$26.25

Wright

SKU	Color	Each
QG.1304.WR.02	Satin Nickel	\$30.45
QG.1304.WR.07	Oil Rubbed Bronze	\$30.45
QG.1304.WR.08	Black	\$27.50

Stick

SKU	Color	Each
QG.1304.ST02	Satin Nickel	\$30.45
QG.1304.ST07	Oil Rubbed Bronze	\$30.45
QG.1304.ST08	Black	\$27.30

Vista

SKU	Color	Each
QG.1304.V02	Satin Nickel	\$54.60
QG.1304.V07	Oil Rubbed Bronze	\$54.60
QG.1304.V08	Black	\$53.55

Cube Stick

SKU	Color	Each
QG.1304.CS.02	Satin Nickel	\$30.45
QG.1304.CS.07	Oil Rubbed Bronze	\$30.45
QG.1304.CS.08	Black	\$26.25

Tri-Star

SKU	Color	Each
QG.1304.TS.02	Satin Nickel	\$42.74
QG.1304.TS.07	Oil Rubbed Bronze	\$30.45
QG.1304.TS.08	Black	\$40.43



Round Stick
2.75" W x 6.67" H



Horseshoe
4.12" W x 6.17" H



Hook
2.50" W x 7.75" H



Basic Rectangle
2.62" W x 5.00" H



Cube Stick
2.90" W x 6.80" H



Stick
2.50" W x 9.75" H



Vista
2.50" W x 6.25" H



Wright
2.25" W x 7.63" H



Top Mount
4.50" W x 3.50" H



Tri-Star
4.625 in. W x 5.5 in. H

Available Finishes:



Satin Nickel



Oil Rubbed Bronze



Black



2 Select Round Aluminum Rails and Rail Accessories

Top to Bottom: Satin Nickel, Oil Rubbed Bronze, Black, & New Age Rust Finishes

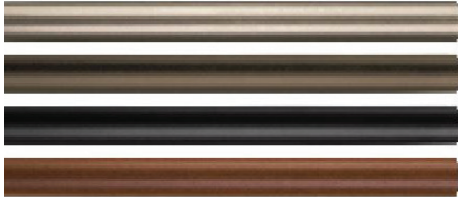

Round Aluminum Rail for Rolling Barn Doors

Hang your rolling barn doors on our sturdy, solid, 1-inch diameter aluminum rails. You can even join multiple rails together using splice kits. **8-foot rails incur an additional shipping fee.**

SKU	Length	Color	Each
QG.4004.02	4-foot	Satin Nickel	\$64.05
QG.4004.07	4-foot	Oil Rubbed Bronze	\$64.05
QG.4004.08	4-foot	Black	\$58.80
QG.4006.02	6-foot	Satin Nickel	\$90.30
QG.4006.07	6-foot	Oil Rubbed Bronze	\$90.30
QG.4006.08	6-foot	Black	\$85.05
QG.4008.02	8-foot	Satin Nickel	\$118.65
QG.4008.07	8-foot	Oil Rubbed Bronze	\$118.65
QG.4008.08	8-foot	Black	\$110.25

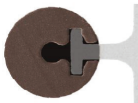

Our solid round rails come extruded with a special profile. This allows for easy attachment to wall mounting brackets, end caps, and splice kits.

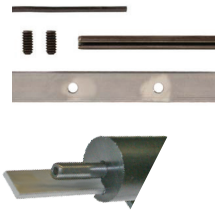

Splice Kit for Joining Round Rails Together

SKU	Size	Kit
QG.41	1/2" 1 1/8" bar	\$1155



Thread Tap Accessory

Accessory used to make threads at the end of rails for end caps.



SKU	Size	Each
QG.TAP.420	1/4" 20 tap	\$10.50



Standard End Cap Kit for Round Rails

Made out of solid steel. Kit includes:
 - 2 Caps (1 1/4" diameter)
 - 2 Fastening bolts (1/4" x 20 x 18mm)

SKU	Color	Kit
QG.40.02	Satin Nickel	\$27.30
QG.40.07	Oil Rubbed Bronze	\$27.30
QG.40.08	Black	\$26.25



Ball End Cap Kit for Round Rails

Made out of aluminum. Ball cap measures 1 1/2" dia. and has a 1/40" screw. Each kit includes 2 ball caps.

SKU	Color	Kit
QG.401.02	Satin Nickel	\$70.00
QG.401.07	Oil Rubbed Bronze	\$70.00
QG.401.08	Black	\$70.00

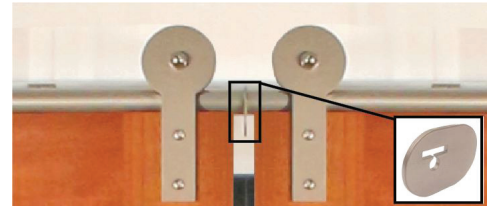

Center Door Stop for Biparting Applications

Stops your biparting door(s) in the middle where rails are joined. Use with two rail sections and a splice kit.

SKU	Color	Each
QG.402.02	Satin Nickel	\$8.40
QG.402.07	Oil Rubbed Bronze	\$8.40
QG.402.08	Black	\$7.35

3 Select Wall-Mounting Brackets

Wall-Mounting Bracket for Round Rails

Choose between short and long brackets (depending on how far you want the door from the wall). Sold as each. Screws are included.

These brackets are used to mount the round rail to the wall. Recommended spacing between brackets is 16".

Wall brackets must be mounted securely into a wood header. If the brackets are to be mounted to the moulding surrounding the opening of the door, the moulding must be firmly secured to the wall framework.

OR

Ceiling-Mounting Bracket for Round Rails

Choose between short and long brackets (depending on how low you want your ladder or door). Sold as each. Screws are included.

These brackets are used to mount the round rail to the ceiling. Recommended spacing between brackets is 16".

Ceiling brackets must be mounted securely into a wood header.

Short Bracket

Accommodates doors up to 15/8" thick. Dimensions:

2-5/8" x 1" W x 1" D

SKU	Finish	Each
QG.203.02	Satin Nickel	\$1155
QG.203.07	Oil Rubbed Bronze	\$1155
QG.203.08	Black	\$1050



Long Bracket

Accommodates doors up to 2 1/4" thick. Dimensions:

2-5/8" x 3/4" W x 1-5/8" D

SKU	Finish	Each
QG.201.02	Satin Nickel	\$1155
QG.201.07	Oil Rubbed Bronze	\$1155
QG.201.08	Black	\$1050



Short Bracket

SKU	Finish	Each
QG.201.CMRD.02	Satin Nickel	\$92.40
QG.201.CMRD.07	Oil Rubbed Bronze	\$77.70
QG.201.CMRD.08	Black	\$79.80
QG.203.CM-RD.02	Satin Nickel	\$90.30
QG.203.CM-RD.07	Oil Rubbed Bronze	\$90.30
QG.203.CM-RD.08	Black	\$78.75

Long Bracket

SKU	Finish	Each
QG.201.CMLL.02	Satin Nickel	\$98.70
QG.201.CMLL.07	Oil Rubbed Bronze	\$78.75
QG.201.CMLL.08	Black	\$85.05
QG.301.CMLL.02	Satin Nickel	\$98.70
QG.301.CMLL.07	Oil Rubbed Bronze	\$85.05
QG.301.CMLL.08	Black	\$85.05

4 Select Door Guides & Stops

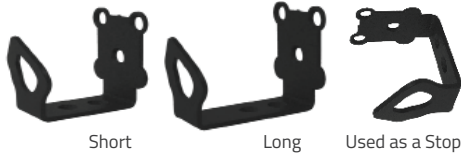

Floor or Wall Universal Guide/Stop, Non-Handed

This product can be used as either a guide or a door stop, mounted onto the floor or to the wall. Sold as each.

Use with Short Bracket (QG.203.**)

SKU	Size	Finish	Each
QG.1306.01.02	1 7/8	Satin Nickel	\$1365
QG.1306.01.07	1 7/8	Oil Rubbed Bronze	\$1365
QG.1306.01.08	1 7/8	Black	\$1260

Use with Long Bracket (QG.201.**)

SKU	Size	Finish	Each
QG.1306.02.02	2 1/2	Satin Nickel	\$1785
QG.1306.02.07	2 1/2	Oil Rubbed Bronze	\$1785
QG.1306.02.08	2 1/2	Black	\$1575



Hand Forged, Hammered Spade Center Guide

Guide can be adjusted to accommodate various door thicknesses. Rear bracket and screws are included.

SKU	Finish	Set
QG.1101.07	Oil Rubbed Bronze	\$47.25
QG.1101.08	Black	\$7.25



Hand Forged, Hammered Spade Door Stop

Each stop includes screws and a rubber bumper. Left and right stops sold separately.

SKU	Finish	Each
Left Stop		
QG.1102.07	Oil Rubbed Bronze	\$38.85
QG.1102.08	Black	\$36.75
Right Stop		
QG.1103.07	Oil Rubbed Bronze	\$8.85
QG.1103.08	Black	\$36.75



Hand Forged, Hammered Fleur-de-Lis Center Guide

Guide can be adjusted to accommodate various door thicknesses. Rear bracket and screws are included.

SKU	Finish	Set
QG.1201.07	Oil Rubbed Bronze	\$25.20
QG.1201.08	Black	\$25.20



Hand Forged, Hammered Fleur-de-Lis Door Stop

Each stop includes screws and a rubber bumper. Left and right stops sold separately.

SKU	Finish	Each
Left Stop		
QG.1202.07	Oil Rubbed Bronze	\$23.10
QG.1202.08	Black	\$23.10
Right Stop		
QG.1203.07	Oil Rubbed Bronze	\$23.10
QG.1203.08	Black	\$23.10



Non-Hammered Spade Center Guide

Guide can be adjusted to accommodate various door thicknesses. Rear bracket and screws are included.

SKU	Finish	Set
QG.1101.NH.07	Oil Rubbed Bronze	\$1575
QG.1101.NH.08	Black	\$13.65



Non-Hammered Spade Door Stop

Each stop includes screws and a rubber bumper. Left and right stops sold separately.

SKU	Finish	Each
Left Stop		
QG.1102.NH.07	Oil Rubbed Bronze	\$1365
QG.1102.NH.08	Black	\$1260
Right Stop		
QG.1103.NH.07	Oil Rubbed Bronze	\$1365
QG.1103.NH.08	Black	\$1260



Non-Hammered Fleur-de-Lis Center Guide

Guide can be adjusted to accommodate various door thicknesses. Rear bracket and screws are included.

SKU	Finish	Set
QG.1201.NH.07	Oil Rubbed Bronze	\$1575
QG.1201.NH.08	Black	\$1575

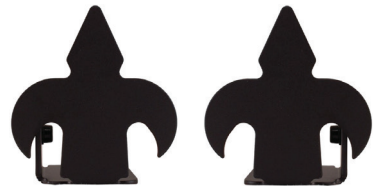

Non-Hammered Fleur-de-Lis Door Stop

Each stop includes screws and a rubber bumper. Left and right stops sold separately.

SKU	Finish	Each
Left Stop		
QG.1202.NH.07	Oil Rubbed Bronze	\$1365
QG.1202.NH.08	Black	\$1365
Right Stop		
QG.1203.NH.07	Oil Rubbed Bronze	\$1365
QG.1203.NH.08	Black	\$1365

"This Round Rail Rolling Door is a great way to have a door if a pocket door cannot be installed... Follow the tutorial on the website and it will come out super nice."

-Dave from Minnesota



Watch our Round Rail installation video on YouTube!



cshardware round rail install



Steel Round Rail Door Stop

Stops the rolling door from the top instead of the bottom. Mounts onto the round rail. Includes a rubber ring to protect door hardware. Fasteners included.

Note: Additional center floor guides are required to keep door rolling in a straight path.

SKU	Color	Each
NT.1404.02	Satin Nickel	\$22.05
NT.1404.07	Oil Rubbed Bronze	\$22.05
NT.1404.08	Black	\$22.05

Plastic Channel

Use with the Brown Plastic Floor Guide. Allows for smooth operation and protects the door from wear and tear. Can be trimmed to size.

Requires 1/4" wide x 1/2" deep slot in the bottom of the door.

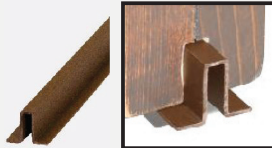

SKU	Size	Each
QG.1313.CH8.07	36"	\$8.40
QG.1313.CH48.07	48"	\$9.45

Dome Door Stop, Non-Handed

Each stop is interchangeable and can be used as either a left or a right stop. Includes screws and a rubber bumper.



SKU	Finish	Each
QG.1305.DS.02	Satin Nickel	\$1260
QG.1305.DS.07	Oil Rubbed Bronze	\$1260
QG.1305.DS.08	Black	\$1155



Roller Center Guide for Rough Door Surfaces

Use this rolling guide for doors with rough surfaces (reclaimed barn wood or rustic finishes). Constructed of heavy duty black Delron polymer, this guide also includes a mounting bolt.

SKU	Length	Color	Each
QG.1000.08	2 13/16	Black	\$3.10

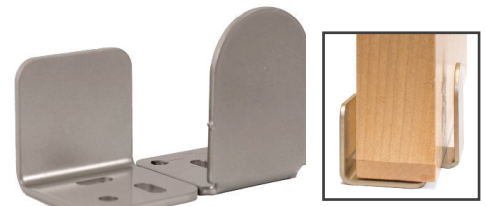

Dome Center Guide Kit

Guide can be adjusted to accommodate various door thicknesses. Available in 4 finishes. Rear bracket and screws are included.

SKU	Finish	Kit
QG.1301.DG.02	Satin Nickel	\$1260
QG.1301.DG.07	Oil Rubbed Bronze	\$1260
QG.1301.DG.08	Black	\$1155



Floor Guide for Doors with a Slotted Bottom

Each set includes installation screws.

SKU	Type	Each
NT.1403.08	Black Plastic	\$1.05
NT.1413.55	Stainless Steel	\$8.40
QG.1303.FG.07	Brown Plastic	\$1.05



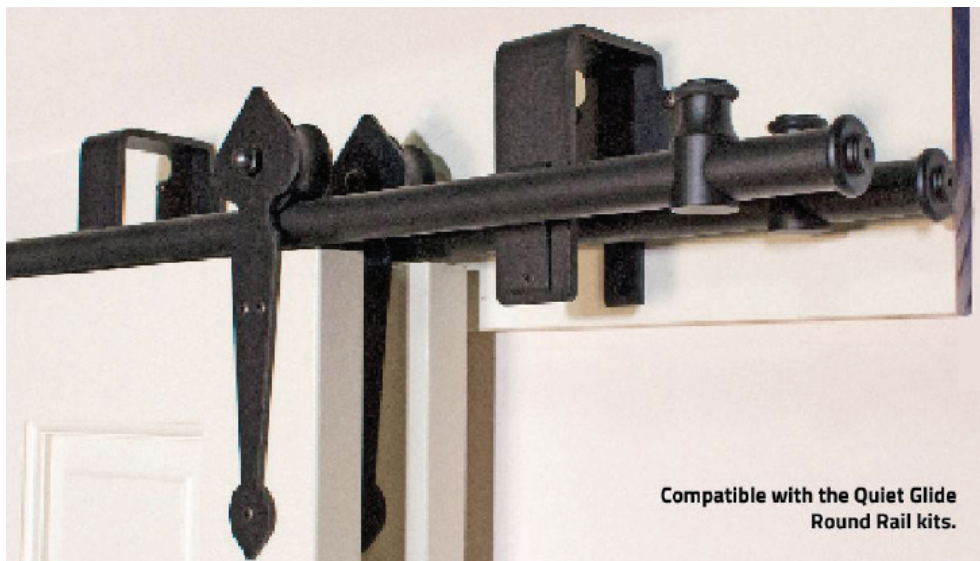

Compatible with the Quiet Glide Round Rail kits.

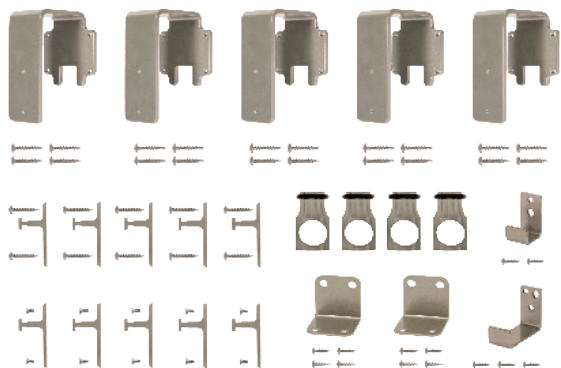

Each Round Rail Bypassing Hardware Kit Includes:

- 5 - Bypassing Brackets
- 5 - Rail Brackets with Long Screws
- 5 - Rail Brackets with Short Screws
- 4 - Steel Door Stoppers
- 1 - Wall-Mounted Guide
- 1 - Door-Mounted Guide
- 2 - Stop Slots
- All Necessary Fasteners

*Max door thickness - 1 1/2"

Round Rail By-Passing Hardware

Introducing the perfect way to install a by-passing door using either our Quiet Glide Round Rail or American Home collection rolling barn door kits! Each kit includes everything you need to combine two sets of rolling barn door hardware into a beautiful and impressive by-passing door.

Please note that the barn door hardware kits themselves are sold separately from by-passing hardware kits.



Round Rail By-Passing Hardware Add-On Kit, Available in Three Finishes
Heavy Duty 1 1/4" Steel.

Overall Dimensions:
5 5/8" Height x 3 1/4" Depth x 3 1/4" Width
The top of bracket will extend 4" above the center of the rail.

SKU	Finish	Kit
QG.1312.01.02	Satin Nickel	\$253.05
QG.1312.01.07	Oil Rubbed Bronze	\$253.05
QG.1312.01.08	Black	\$253.05



Flat Rail Collection

Made in the USA!

This hardware is Quiet Glide's Premium-quality take on the flat-rail style of rolling barn door hardware. Unlike the competition, we use aluminum rails that are easy to cut to size and give you the ability to drill holes for placing the mounting hardware exactly where you need it.

The minimal contact surface area between the flat rail design and the high-density nylon wheel make for extra quiet operation, and the hardware safely supports a max recommended weight of 250 lbs.

Beautifully traditional yet striking, the simple aesthetics of Quiet Glide's Flat Rail Collection are sure to accent your unique decor!

Each 6' Flat Rail Kit Includes:

- 2 - Straps with Rollers
- 1 - 6' Flat Rail Segment
- 1 - Stop Kit
- 5 - Flat Rail Mounting Brackets
- 1 - Floor Center Guide
- All necessary fasteners

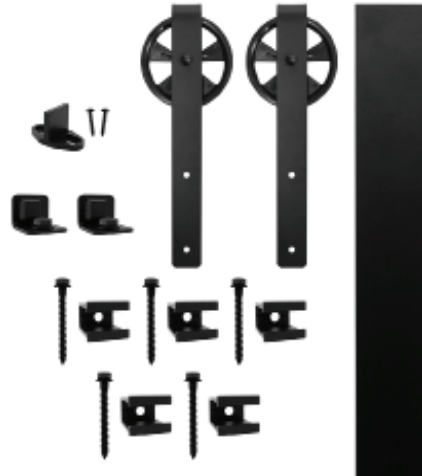

Available Finishes:

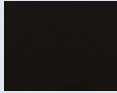

Black



Flat Rail 6' Kits:



Flat Rail Kit - Hook Strap with 5" Wheel

SKU	Finish	Kit
QG.FR1300.HK5.08	Black	\$175.35



Flat Rail Kit - Hook Strap with 3" Wheel

SKU	Finish	Kit
QG.FR1300.HK3.08	Black	\$162.75



Flat Rail Kit - Stick Strap with 3" Wheel

SKU	Finish	Kit
QG.FR1300.ST3.08	Black	\$152.25



Flat Rail Kit - Top Mount Strap with 3" Wheel

SKU	Finish	Kit
QG.FR1300.TM3.08	Black	\$154.35

Flat Rail Accessories:

Our kits have all the parts you need for a standard 6' rolling door application. If you wish to customize your door (including having a rail longer than 6'), we have additional components available for purchase.



4', 6', and 8' Rail (can be cut to size)

These aluminum rails are sturdy, yet easy to cut. Each rail measures 2" high. 5/16" holes must be drilled through rail in order to fasten to mounting brackets.

SKU	Size	Finish	Each
QG.FR4004.08	4'	Black	\$36.75
QG.FR4006.08	6'	Black	\$46.20
QG.FR4008.08	8'	Black	\$64.05

5/16" Drill Bit



SKU	Each
QG.DRILLBITS1Ø	\$7.35



Flat Rail Movable Bracket Kit

Can be positioned exactly where you need them, such as above the stud in your wall! Includes one bracket, one lag bolt, and one washer. For doors up to 13/4"

SKU	Finish	Per Kit
QG.FR201.08	Black	\$4.20

Flat Rail Stop Kit

Kit includes two stops and fasteners.



SKU	Finish	Per Kit
QG.FR40.08	Black	\$9.45



Splice Kit for Joining Flat Rails Together

SKU	Finish	Per Kit
QG.FR41.08	Black	\$9.45



Floor Guide for Doors with a Slotted Bottom

SKU	Type	Each
NT.1403.08	Black Plastic	\$1.05
QG.1303.FG.07	Brown Plastic	\$1.05

Plastic Channel

Use with the Brown Plastic Floor Guide. Protects the door from wear and tear. Can be trimmed to size. Requires a 1/4" wide x 1/2" deep slot in the bottom of the door.



SKU	Size	Each
QG.1313.CH6.07	36"	\$8.40
QG.1313.CH48.07	48"	\$9.45

Rolling Door Collection



White Satin Nickel Antique Brass Chrome



Satin Brass PVD Coated Oil Rubbed Bronze Black



Oil Rubbed Bronze

Designer's Collection Hook Strap Kit with Small 2.75" Wheels

Customize your door's style with one of our newest flat rail kits! For use with doors measuring between 1-3/8" and 1-3/4" thick. All major components and fasteners are finished in its corresponding color. Fits 32" and 36" openings. Maximum weight capacity is 220 lbs.

SKU	Finish	Kit
78.75" Rail Length		
NT.1400.09W.01	White	\$144.90
NT.1400.09W.02	Satin Nickel	\$161.70
NT.1400.09W.03	Antique Brass	\$156.45
NT.1400.09W.04	Chrome	\$229.95
NT.1400.09W.06PVD	Satin Brass PVD Coated	\$235.20
NT.1400.09W.07	Oil Rubbed Bronze	\$204.75
NT.1400.09W.08	Black	\$173.25
96" Rail Length		
NT.1400.09W-96.01	White	\$156.45
NT.1400.09W-96.02	Satin Nickel	\$198.45
NT.1400.09W-96.03	Antique Brass	\$169.00
NT.1400.09W-96.04	Chrome	\$230.00
NT.1400.09W-96.06PVD	Satin Brass PVD Coated	\$241.50
NT.1400.09W-96.07	Oil Rubbed Bronze	\$169.00
NT.1400.09W-96.08	Black	\$160.65

Each Designer's Collection Hook Strap Kit Includes:

- 2 - Straps with Rollers
- 1 - 78.75" or 96" Flat Rail
- 2 - Rail Stops
- 2 - Anti-Jump Blocks
- 5 - Rail Brackets
- 1 - Floor Center Guide
- All fasteners

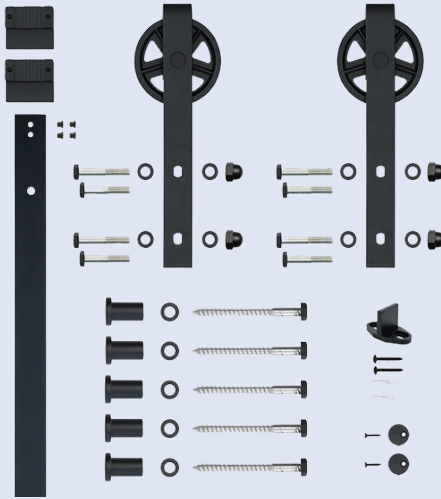

Designer's Collection 2m (78.75") Hook Strap Kit with Large 4.75" Spoke Wheels

One of the most affordable rolling door kits around! You can get this steel, powder-coated black kit for your 32" or 36" door openings. For use with doors measuring between 1-3/8" and 1-3/4" thick. Maximum weight is 220lbs.

NT.1400.08W.08 Black \$157.50

Designer's Collection Accessories:



Steel By-Pass Door Bracket - BUY 5 FOR A COMPLETE SET

Compatible with any Designer's Collection door kit. For a complete by-pass set for a Designer's Collection kit, you must purchase 5 by-pass door brackets. Fasteners are included. 101/2" clearance required from center of rail to the top of bracket.

SKU NT.1423.08 Each Bracket \$17.85

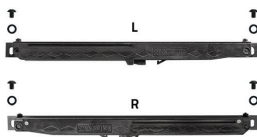

Designer's Collection Soft-Close Mechanism Kit

Make your door's motion extra smooth and quiet with this soft-close mechanism kit! Purchase one Soft-Close Mechanism per Rolling Door Kit. Includes (2) L&R Soft-close mechanisms, (2) L&R Actuators and all required fasteners.

SKU NT.1424.08 Kit \$6.75

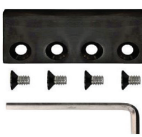

Steel Flat Rail Connector Kit

This kit is used to join flat rails together. Compatible with any Designer's Collection kit. Screws and Allen wrench are included.

NT.1419.08 \$6.72

Designer's Collection

The CSH Designer's Collection Rolling Door Kit for 1-3/8" to 1-3/4" thick doors in a 32" or 36" door opening is our solution for the cost-conscious buyer!

The black powder-coated steel hardware has a versatile look that is perfect for any interior space and it's sturdy enough to support a loading weight of up to 220 lbs.



This application uses 2 Large Spoke Wheel Hook Strap Kits with 5 By-Pass Door Brackets



Steel Flat Rail Door Stop

This steel stop comes with soft rubber linings to better adhere to the rail. Compatible with the Large Spoke Wheel kit. Sold as each. Fasteners are included.

NT.1420.08 \$26.25



Door-Mounted Guide

SKU	Color	Each
QG.1302.BPG.02	Satin Nickel	\$24.15
QG.1302.BPG.07	Oil Rubbed Bronze	\$24.15
QG.1302.BPG.08	Black	\$24.15



Wall-Mounted Guide

SKU	Color	Each
QG.1302.BPWG.02	Satin Nickel	\$24.15
QG.1302.BPWG.07	Oil Rub Bronze	\$24.15
QG.1302.BPWG.08	Black	\$24.15



Guide End Stops

SKU	Color	Kit
QG.1302.BPSS.02	Satin Nickel	\$24.15
QG.1302.BPSS.07	Oil Rub Bronze	\$24.15
QG.1302.BPSS.08	Black	\$24.15

Kit includes 2 brackets and fasteners

Floor Guide for Doors with Slotted Bottom, Plastic

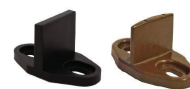

SKU	Color	Each
NT.1403.08	Black	\$1.05
QG.1303.FG.07	Brown	\$1.05



Plastic Channel

Use with the Plastic Floor Guide. Can be trimmed to size. Requires a 1/4" wide x 1/2" deep slot in the bottom of the door.

SKU	Length	Each
QG.1313.CH8.07	36"	\$8.40
QG.1313.CH48.07	48"	\$9.45

Handles, Pulls, Latches

Made in the USA!

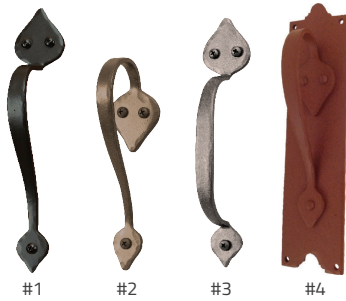

Hand-Forged Iron Door Handle

Design #1, 9" H x 1 13/16" W x 1 5/8" D
 QG.1P9.01.02 Satin Nickel \$66.15
 QG.1P9.01.08 Black \$65.10

Design #2, 6 3/4" H x 1 13/16" W x 2 1/8" D
 QG.1P9.02.02 Satin Nickel \$66.06
 QG.1P9.02.07 Oil Rubbed Bronze \$58.91
 QG.1P9.02.08 Black \$58.91

Design #3, 8 1/2" H x 1 13/16" W x 1 5/8" D
 QG.1P9.03.02 Satin Nickel \$63.53
 QG.1P9.03.08 Black \$62.37

Design #4, 8 3/4" OAH x 2 3/8" OAW x 2 3/8" D
 QG.1P9.04.02 Satin Nickel \$123.59
 QG.1P9.04.07 Oil Rubbed Bronze \$122.43
 QG.1P9.04.08 Black \$123.43



Solid Brass Door Pull

Measures 6" tall with 1 3/4" projection. Screws are included.

DA.WP27U10B Solide Brass \$35.77
 DA.WP27U9 Black \$35.77

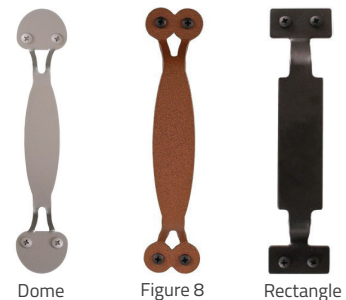

Laser-Cut Steel Handles

These beautiful handles are laser cut from 1/8" thick steel right here in Wisconsin. They come in 6 styles and 4 different powder coatings to match any decor.

Rectangle, 8 5/8" H x 1 13/16" W x 1 1/2" D
 QG.1399.04.02 Satin Nickel \$23.10
 QG.1399.04.07 Oil Rubbed Bronze \$23.10
 QG.1399.04.08 Black \$23.10



Recessed Rectangle Flush Pull

Ideal for use on the inside of rolling barn doors. Each pull comes with necessary screws. Use straight router bits to create a clean recess.

7-Inch Flush Pull - 7" x 1 7/8" x 7/16"
 DA.FP7178U15 Satin Nickel \$35.51
 DA.FP7178U10B Oil Rubbed Bronze \$35.51
 DA.FP7178U9 Black \$35.51

4-Inch Flush Pull - 4" x 1 3/4" x 7/16"
 DA.FP4134U15 Satin Nickel \$21.90
 DA.FP4134U10B Oil Rubbed Bronze \$21.90
 DA.FP4134U9 Black \$21.90

Latch and Strike Plate Set to Lock Rolling Barn Doors

Latch your rolling barn door from the inside using this convenient hardware set. Screws are included.

Stainless Steel Latch - 3" x 2 3/8"
 NT.1479.01.SS Stainless Steel \$9.45

Traditional Latch - 2 3/4" x 1 13/16"
 QG.1307.01.02 Satin Nickel \$19.95
 QG.1307.01.07 Oil Rubbed Bronze \$19.95
 QG.1307.01.08 Black \$15.75



Traditional Stainless Steel

NT Handles



SKU	Finish	Each
NT.1499.02.02	Satin Nickel	\$36.00
NT.1499.02.07	Oil Rubbed Bronze	\$36.00
NT.1499.02.08	Black	\$36.00
NT.1499.02.SS	Stainless Steel	\$83.00

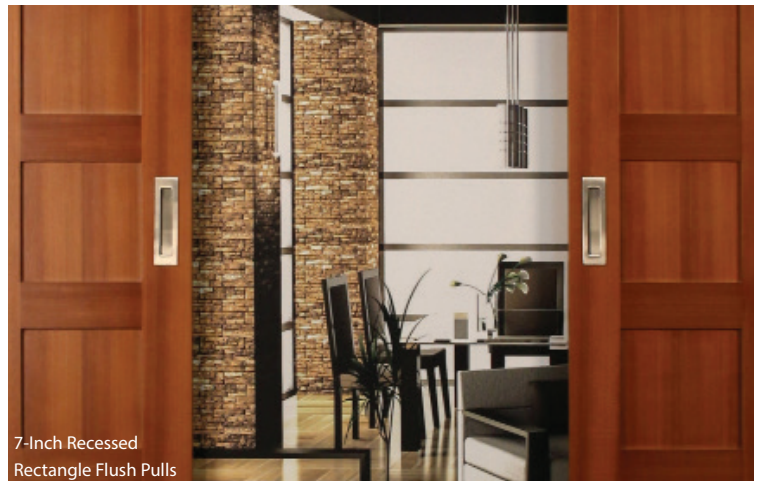

7-Inch Recessed Rectangle Flush Pulls

Recessed Flushed Pull

3-1/8" High x 1-3/8" Wide x 1/2" Deep

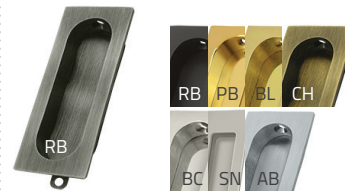

SKU	Finish	Each
DA.FP222CR003	PVD	\$17.42
DA.FP222U10B	Oil Rubbed Bronze	\$16.16
DA.FP222U14	Polished Nickel	\$15.39
DA.FP222U15	Satin Nickel	\$15.39
DA.FP222U26D	Brushed Chrome	\$15.39
DA.FP222U3	Polished Brass	\$14.34

Recessed Round Flushed Pull

2-1/8" Diameter x 1/4" Deep

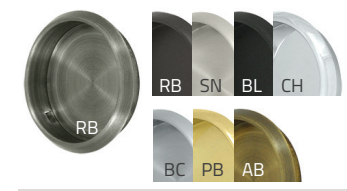

SKU	Finish	Each
DA.FP221RU10B	Oil Rubbed Bronze	\$4.30
DA.FP221RU15	Satin Nickel	\$4.30
DA.FP221RU9	Paint Black	\$4.30
DA.FP221RU26	Chrome	\$4.10
DA.FP221RU26D	Brushed Chrome	\$4.10
DA.FP221RU3	Polished Brass	\$3.69



Recessed Square Flushed Pull

2-3/4" Square, Outside Dimension
 7/16" Deep

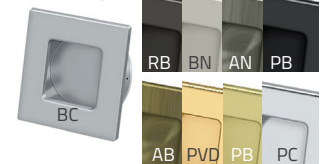

SKU	Finish	Each
DA.FPS234CR003	PVD	\$28.35
DA.FPS234U15	Brushed Nickel	\$27.73
DA.FPS234U15A	Antique Nickel	\$26.41
DA.FPS234U9	Paint Black	\$27.73
DA.FPS234U26	Polished Chrome	\$26.41
DA.FPS234U26D	Brushed Chrome	\$26.41
DA.FPS234U3	Polished Brass	\$24.47
DA.FPS234U5	Antique Brass	\$26.41
DA.FPS234U510B	Rubbed Bronze	\$32.97



InvisiDoor

Pivot Bookcase Door

Made in the USA!



Do you want a hidden room? Or maybe a safe room? Well, now you don't have to pay custom prices and suffer through long delays to do it! Conceal a seldom-used room, create a hidden safe room, or turn a door into a functional storage/display area with an InvisiDoor bookcase! Our in-stock and ready-to-ship InvisiDoor hidden bookcase kits come assembled and ready to install with our unique pivot hinge. Hardware is also sold separately for custom installations.



Pivot Bookcase Door Kit for 32" Finished Openings -

In Stock & Ready to Ship

Measures 30 7/8" W x 78 7/8" H x 8" D. Available in three wood species.

SKU	Wood Species	Kit
ID.BC32.CH	Cherry	\$128.00
ID.BC32.MA	Maple	\$125.00
ID.BC32.RO	Red Oak	\$125.00



Pivot Bookcase Door Kit for 36" Finished Openings -

In Stock & Ready to Ship

Measures 34 7/8" W x 78 7/8" H x 8" D. Available in three wood species.

SKU	Wood Species	Kit
ID.BC36.CH	Cherry	\$1350.00
ID.BC36.MA	Maple	\$325.00
ID.BC36.RO	Red Oak	\$199.00

Inswing

Outswing



- Sized to fit standard openings for a 32" or 36" door.
- Bookcases are fully assembled and unfinished.
- Can be hinged left or right as an inswing or outswing application.
- Made with premium plywood and domestic hardwoods.
- Simple installation with our unique pivot hinge.
- Ships via truckline to protect items.

Each Bookcase Door Kit Includes:

- 1 - Assembled bookcase
- 1 - Pivot hinge kit (with fasteners)
- 3 - Adjustable shelves
- 12 - Shelf supports
- 1 - Support/Stop
- Installation instructions



InvisiDoor Pivot Hinge Kit

Want to build your own InvisiDoor? Here's the hinge kit you need to do it! Can be used for inswing, outswing, left, or right applications. Includes a support foot/stop and fasteners. Installation instructions included.

Hinge plate size: 5 7/8" x 11 1/2" x 1/4"

SKU	Kit
ID.HINGEKIT	\$149.00

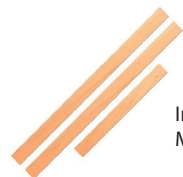

InvisiDoor Trim Moulding Kit

Use this kit to build a frame for your inswing or outswing bookcase.

- Includes:
- 2 - 3 1/2" x 84" x 3/4" boards
- 1 - 3 1/2" x 48" x 3/4" board

SKU	Wood Species	Set
ID.TK.CH	Cherry	\$140.00
ID.TK.MA	Maple	\$128.00
ID.TK.RO	Red Oak	\$128.00

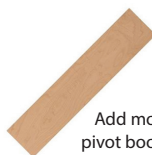

Additional Shelf for Pivot Bookcase

Add more shelves to your pivot bookcase door. Comes unfinished and includes shelf pins.

SKU	Wood Species	Set
For 32" Opening Bookcases		
ID.SHELF32.CH	Cherry	\$26.00
ID.SHELF32.MA	Maple	\$24.00
ID.SHELF32.RO	Red Oak	\$20.00
For 36" Opening Bookcases		
ID.SHELF36.CH	Cherry	\$24.00
ID.SHELF36.MA	Maple	\$24.00
ID.SHELF36.RO	Red Oak	\$24.00



InvisiDoor Jamb/Threshold Kit for Inswing or Outswing Applications

Simplify your installation with a ready-to-assemble jamb/threshold kit. Finished opening size is 36" W x 80" H.

- Includes:
- 1 - 7" D threshold
- 1 - 49/16" jamb set (top header and two sides)

SKU	Wood Species	Set
Inswing Applications		
IDJAM36IS.CH	Cherry	\$266.00
IDJAM36IS.MA	Maple	\$219.00
IDJAM36IS.RO	Red Oak	\$194.00
Outswing Applications		
IDJAM36OS.CH	Cherry	\$261.00
IDJAM36OS.MA	Maple	\$212.00
IDJAM36OS.RO	Red Oak	\$193.00



InvisiDoor Flat Panel Door Set

Add another layer of secrecy to your hidden bookcase with this door set. Includes 2 doors, 4 hinges and all required fasteners.

SKU	Wood Species	Set
For 32" Opening Bookcases		
ID.DOOR32FPCH	Cherry	\$205.00
ID.DOOR32FPMMA	Maple	\$193.00
ID.DOOR32FPRO	Red Oak	\$180.00
For 36" Opening Bookcases		
ID.DOOR36FPCH	Cherry	\$205.00
ID.DOOR36FPMMA	Maple	\$193.00
ID.DOOR36FPRO	Red Oak	\$176.00

Bi-Fold Bookcase Door Made in the USA!

Need an even larger bookcase door? This impressive-looking bi-folding bookcase door is the answer! Bi-folding hardware kits are also available if you'd rather construct your own!



Conceal a

- safe
- closet
- panic room
- food pantry
- laundry room
- storage room
- gun storage area

Bi-Fold Bookcase Door & Hardware Kit with Valance

Comes in three sizes and is available in three wood species.

SKU	Wood Species	Each
48" Bookcase		
ID.BF48.CH	Cherry	\$2200.00
ID.BF48.MA	Maple	\$2009.00
ID.BF48.RO	Red Oak	\$2075.00
60" Bookcase		
ID.BF60.CH	Cherry	\$2529.00
ID.BF60.MA	Maple	\$2391.00
ID.BF60.RO	Red Oak	\$2391.00
72" Bookcase		
ID.BF72.CH	Cherry	\$2839.00
ID.BF72.MA	Maple	\$2718.00
ID.BF72.RO	Red Oak	\$2718.00

- Bookcases are fully assembled and unfinished
- Made with solid hardwood and cabinet-grade plywood (no melamine)
- Easily installs in new construction or in front of existing openings
- Turns closet doors into exciting display space
- Valance bookcases for use with any opening up to 6 feet
- Bookcases ship via truckline
- InvisiDoor hardware is guaranteed for life
- Call for quote on custom bookcase sizes

Hardware Kits to build your own Bi-Fold InvisiDoor:

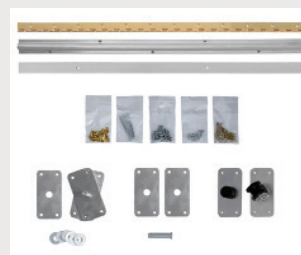

Bi-Fold Bookcase Door Hardware Kit with Valance
Use this kit to build your own bi-folding bookcase and overhead valance.

SKU	Kit
ID.BFHARDWAREKIT	\$241.00

Hide-A-Shelf

How can you keep your valuables easily accessible in central, high-traffic areas of your home, yet secure, out of the way of dust and clutter, and out of sight for unexpected visitors? The answer is to conceal your storage space within a tasteful, high-quality piece of home décor and secured by a reliable, discreet, and fast locking mechanism.

Create your own InvisiShelf with our convenient do-it-yourself kit. This kit is designed to work with a shelf 20-28" in length. Kit comes with everything needed to produce our hidden shelf - you choose your own wood and fasteners. Instructions for building included.

SKU	Wood Species	Price
ID.CS-DIY.01.KIT	DIY Kit for 20-28" shelf	\$1805.00
ID.CS-DIY.02.KIT	DIY Kit for 20-48" shelf	\$200.00



DIY Kit available for those who want to use their own shelf.



*Shelf not included

InvisiDoor Accessories

You've seen it in movies and shows, and you've always wanted one. Now you can make it a reality: a secret bookcase door with a hidden locking mechanism! Choose from three discreet locking options, each one thoughtfully designed with safety and convenience features you'll love.



Secret Book Latch

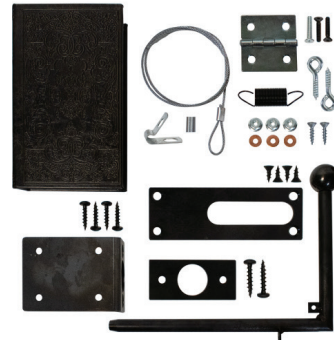

Secret Book Latch Includes:

- (1) Dummy Book
- (1) Hinge w/mounting hardware
- (1) Wire Cable and Wire Crimp
- (2) Eye Screws
- (1) Cane Latch Bar and Knob
- (1) Strike Plate
- Brackets w/mounting hardware
- Easy to follow mounting instructions

SKU	Kit
ID.LATCH-BOOK.08	\$145.00
ID.LATCH-BOOK.08-BF	\$145.00
ID.LATCH-CANE.08	\$122.00



RFID Electronic Lock



RFID Electronic Lock Kit Includes:

- (1) PS-LOCK Solo Lock w/mounting hardware
- (1) Antenna with 12" cord
- (1) Keycard
- (1) Key Fob
- (1) 3" x 3" x 1-1/2" mounting block
- (4) mounting screws 0.FSC08200Un27
- (4) Wire Clips w/mounting hardware
- Easy to follow mounting instructions

SKU	Kit
ID.LOCK-PSLOCK	\$160.00

This RFID electronic locking system works great with the Invisidoor hidden door kits. The SOLO lock is used as a locking device not visible from the outside and is operated with a key card or key fob.

The RFID reading range and battery life depends on the technology used and the quality of the key units (cards, fobs, stickers, bracelets) or battery used.



Stealthlock Keyless Lock



Stealthlock Keyless Lock Kit Includes:

- (1) Receiver Latch (4-AAA batteries required, not included)
- (1) Transmitter Pad
- (1) Cabinet Strike Plate
- (1) Installation Tool

SKU	Kit
SL.SL-100	\$207.61

An innovative keyless cabinet lock operated by radio frequency technology! No losing keys anymore!

The new InvisiDoor Motorized Latch system adds a unique touch to our already market leading InvisiDoor Door system.

From anywhere in your room surprise your guests by opening up your "wall" with the touch of a button!

Motorized Latch Kit

SKU	Application	Kit
ID.LATCH-MOTOR.02	Inswing and Outswing	\$607.75



Inswing Application



Outswing Application



SKU	Application	Kit
ID.LGTT.01.08	Light Kit	\$90.00
ID.SPK.01.08	Sound Kit	\$43.00
ID.SPK-USB.01.08	Sound, USB Port Kit	\$173.00
ID.SPK-SPK-USB.01.08	Light, Sound, USB Port Kit	\$173.00

InvisiDoor Light, Sound, and USB Charging Kit

This InvisiDoor Kit comes with all your accessory needs, from lights to speakers! Pick your kit to fit your needs.

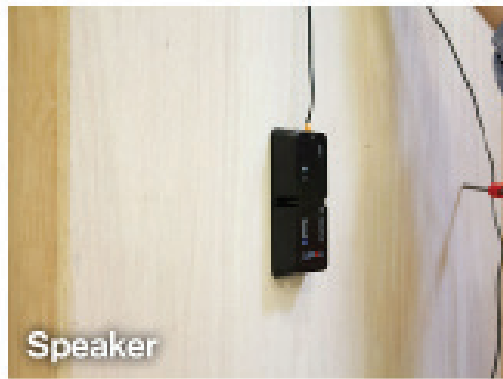
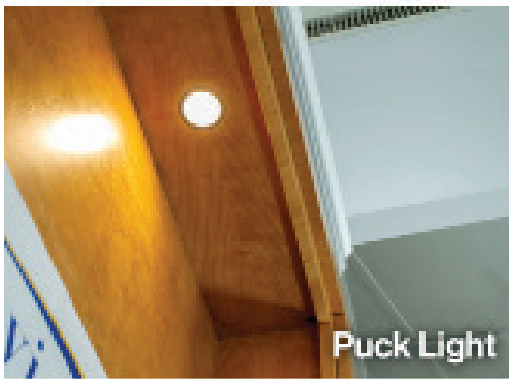
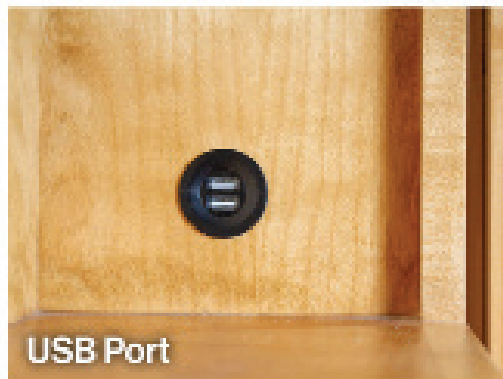
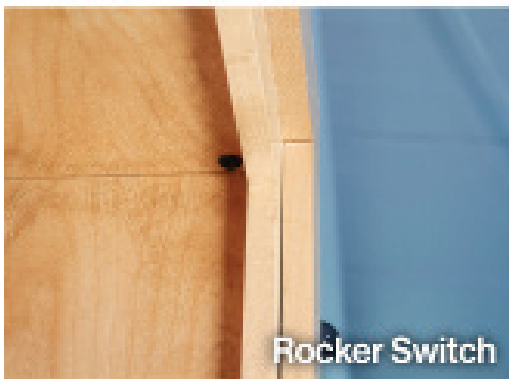

A Closer Look At: Quiet Glide® Library Ladder



High-density nylon wheels for smooth gliding motion.

TOP OPTIONS FOR NON-ROLLING OR ROLLING
Double Roller, Single Roller, Swivel, Non-Rolling Single Hook, or Non-Rolling Double Hook

Solid aluminum track with decorative ball end caps (optional).

**LOFT/
BUNK BED
HARDWARE**

**3 STOCKED HEIGHT
OPTIONS**
8', 9', and 10'
(custom heights available)

Sanded to 120-grit with pre-drilled assembly holes.

**NEW INTEGRATED
LADDER WITH BUILT-
IN HANDLES**

2 WIDTH OPTIONS
16-inch and 20-inch

Dadoed siderails and steel support rods for reinforced step strength.

**4 STOCKED WOOD
SPECIES**
Red Oak, Maple, Cherry
and Walnut
(custom species available)

Non-skid rubber wheels. Glides effortlessly on any floor type.

**NON-SKID FOOT
AVAILABLE FOR
NON-ROLLING
LADDER
APPLICATIONS**

**4 WHEEL TYPES Braking
or Non-Braking**
Sunburst Braking or Non-Braking Style, Braking or Non-Braking Contemporary Style

Ladder Products

Ceiling Mount

Is there no room on your wall to mount a Rolling Ladder or Barn Door? The new ceiling mount allows you to mount either a ladder or door where you couldn't before!

SKU	Finish
QG.201.CM-LL.02	Satin Nickel
QG.201.CM-11.07	Oil Rubbed Bronze
QG.201.CM-LL.08	Black
QG.201.CM-LL.06B	Brushed Satin Brass
QG.201.CM-RD.02	Satin Nickel
QG.201.CM-RD.07	Oil Rubbed Bronze
QG.201.CM-RD.08	Black
QG.203.CM-RD.02	Satin Nickel
QG.203.CM-RD.07	Oil Rubbed Bronze
QG.203.CM-RD.08	Black
QG.301.CM-LL.02	Satin Nickel
QG.301.CM-LL.07	Oil Rubbed Bronze
QG.301.CM-LL.08	Black
QG.301.CM-LL.06B	Brushed Satin Brass

Double Roller Ladder

< 15/8" Door

< 15/8"

Single Roller /Hook Ladder



Outside Corner Mount

This mounting kit allows you to mount your Rolling Ladder on an outside 90-degree corner. Swivel Roller hardware kit is required for this application.

Corner Track

SKU	Finish
QG.40CRV-OS.02	Satin Nickel
QG.40CRV-OS.03	Hamm. Antique Brass
QG.40CRV-OS.07	Oil Rubbed Bronze
QG.40CRV-OS.08	Black



Ladder Assembly

SKU	Finish
QG.7000-01.02	Satin Nickel
QG.7000-01.03	Hamm. Antique Brass
QG.7000-01.07	Oil Rubbed Bronze
QG.7000-01.08	Black



Ladder Assembly for Wide Ladders

SKU	Finish
QG.7000-20.01.02	Satin Nickel
QG.7000-20.01.03	Hamm. Antique Brass
QG.7000-20.01.07	Oil Rubbed Bronze
QG.7000-20.01.08	Black



Prefinished Ladders

SKU	Height	Color
QG.6008.MA-PF	8'	Maple
QG.6008.RO-PF	8'	Red Oak

SKU	Length	Color
QG.6009.MA-PF	9'	Maple
QG.6009.RO-PF	9'	Red Oak

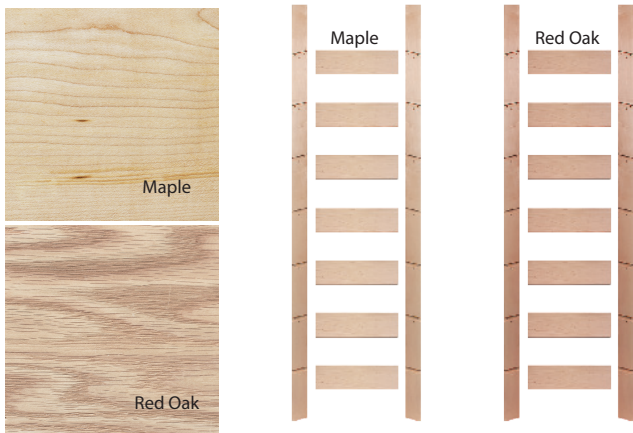

Ladder is topcoated with a high quality 30 sheen conversion finish.

Ordering Note: If you are buying the ladder WITHOUT the rolling ladder kit, you will need one Rung Support Kit (QG.620.08) per step.

NOTE: THIS PART # IS FOR WOOD COMPONENTS ONLY!

8' Ladder includes:	<ul style="list-style-type: none"> • 2 Side Rails • 7 Steps • 1 Top Rung
9' Ladder includes:	<ul style="list-style-type: none"> • 2 Side Rails • 8 Steps • 1 Top Rung

Library Ladder Options

Non-Rolling Library Ladder

We received feedback from many customers who were looking for a removable, non-rolling library ladder, so we developed the single and double hook systems with rubberized non-skid feet. The two different top mount styles provide various ladder storage options; while the non-skid feet provide customers with the comfort of knowing their ladder will safely remain in place while in use! This new hardware allows you to have the movable (but non-rolling) ladder that's perfect for your unique needs!



Rolling Library Ladder



The Quiet Glide Rolling Library Ladder is a classy way to add functionality to your library, closet, wine cellar, kitchen, pantry or office. With the Rolling Ladder it is all about choice! Our unique ladder track system is the only kit on the market that offers solid aluminum tracks (not hollow tubes), and the hardware rollers allow the ladder to be stored in the upright position. All of our Quiet Glide Rolling Ladder parts are machined or manufactured by American craftsmen - from the metal work, to wood work, to the steam-bent handrails! If the stock options are not what you are looking for, we have custom options of wood that we can cut to match any height up to 10 feet. Add a sophisticated and original touch to your home by ordering the rolling ladder that will work best for your application!

Non-Rolling Ladder Top Mount Styles:



Single Hook

Sliding upper guide allows the ladder to be stored in the upright position.



Double Hook

The top hook is for when the ladder is in use, and bottom hook is for storing.

Rolling Ladder Top Mount Styles:



Double Roller

Has a top and a bottom wheel, keeping the ladder fixed onto the rail.



Single Roller

Has only one wheel on the top, so the ladder can be removed easily.



Curved Track Roller

Features a built-in swivel, which allows the ladder to be used on curved rails.

Non-Rolling Library Ladders

Made in the USA!

Step 1 Choose Desired Non-Rolling Library Ladder Hardware



Comes with 7 step supports (enough for 8' ladder).

Non-Skid Foot with Single Hook Kits

SKU	Color
16" Wide Ladder Hardware	
QG.330.02	Satin Nickel
QG.330.07	Oil Rub. Bronze
QG.330.08	Black
QG.330.06B	Brushed Satin Brass
20" Wide Ladder Hardware	
QG.330-20.02	Satin Nickel
QG.330-20.07	Oil Rub. Bronze
QG.330-20.08	Black
QG.330-20.06B	Brushed Satin Brass



Comes with 7 step supports (enough for 8' ladder).

Non-Skid Foot with Double Hook Kits

SKU	Color
16" Wide Ladder Hardware	
QG.130.02	Satin Nickel
QG.130.07	Oil Rub. Bronze
QG.130.08	Black
QG.130.06B	Brushed Satin Brass
20" Wide Ladder Hardware	
QG.130-20.02	Satin Nickel
QG.130-20.07	Oil Rub. Bronze
QG.130-20.08	Black
QG.130-20.06B	Brushed Satin Brass



Comes with 7 step supports (enough for 8' ladder).

Stationary Loft Ladder Hardware

SKU	Color
16" Wide Ladder Hardware	
QG.830.02	Satin Nickel
QG.830.07	Oil Rub. Bronze
QG.830.08	Black
QG.830.06B	Brushed Satin Brass
20" Wide Ladder Hardware	
QG.830-20.02	Satin Nickel
QG.830-20.07	Oil Rub. Bronze
QG.830-20.08	Black
QG.830-20.06B	Brushed Satin Brass

Available Finishes:

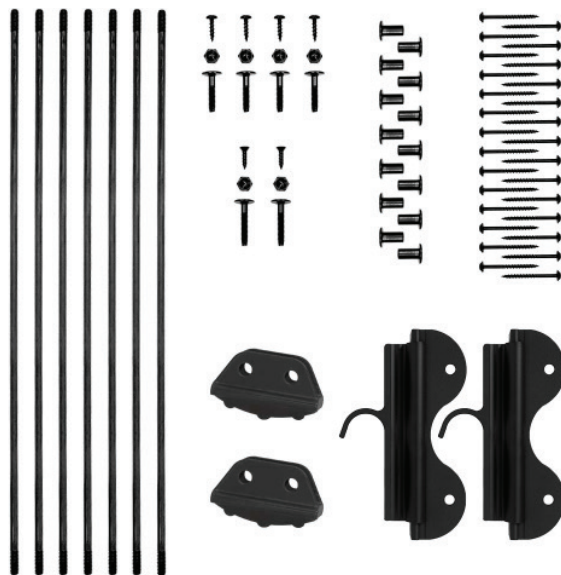
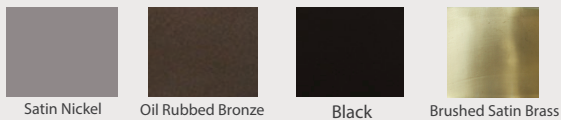

Each Kit Includes:

- 2 Top Mount Assemblies
- 2 Non-Skid Feet
- All Necessary Fasteners
- 7 Step Support Rods (Enough for 8' ladder)

About the Components



Single Hook

Sliding upper guide allows the ladder to be stored in the upright position.



Double Hook

The top hook is for when the ladder is in use, and bottom hook is for storing.



Stationary Loft

Ladder can be stored upright and out of the way. Ladder cannot be moved once fixed in place.



Non-Skid Foot

Designed for stationary applications, it will hold the ladder firmly in place.



Continue to step two to choose your wood ladder and Non-Rolling Library Ladder remaining components.

Rolling Library Ladders

Made in the USA!

Available Finishes:

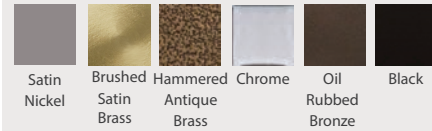

Each kit includes:

- 2 Upper Wheel Assemblies
- 2 Bottom Wheel Assemblies
- All Necessary Fasteners
- 7 Step Support Rods (Enough for 8' ladder)

Step 2 Choose Rolling Library Ladder Hardware



Sunburst Wheel with Double Roller Kits

SKU	Ladder Width	Color
QG.200.02	16"	Satin Nickel
QG.200.03	16"	Hamm. Antique Brass
QG.200.06B	16"	Brushed Satin Brass
QG.200.07	16"	Oil Rubbed Bronze
QG.200.08	16"	Black
QG.200-20.02	20"	Satin Nickel
QG.200-20.03	20"	Hamm. Antique Brass
QG.200-20.06B	20"	Brushed Satin Brass
QG.200-20.07	20"	Oil Rubbed Bronze
QG.200-20.08	20"	Black



Sunburst Wheel with Single Roller Kits

ROLLING HOOK KITS CANNOT BE USED WITH CURVED RAILS

SKU	Ladder Width	Color
QG.500.02	16"	Satin Nickel
QG.500.03	16"	Hamm. Antique Brass
QG.500.06B	16"	Brushed Satin Brass
QG.500.07	16"	Oil Rubbed Bronze
QG.500.08	16"	Black
QG.500-20.02	20"	Satin Nickel
QG.500-20.03	20"	Hamm. Antique Brass
QG.500-20.06B	20"	Brushed Satin Brass
QG.500-20.07	20"	Oil Rubbed Bronze
QG.500-20.08	20"	Black



Sunburst Wheel with Curved Track Roller Kits

SKU	Ladder Width	Color
QG.700.02	16"	Satin Nickel
QG.700.03	16"	Hamm. Antique Brass
QG.700.07	16"	Oil Rubbed Bronze
QG.700.08	16"	Black
QG.700-20.02	20"	Satin Nickel
QG.700-20.03	20"	Hamm. Antique Brass
QG.700-20.07	20"	Oil Rubbed Bronze
QG.700-20.08	20"	Black



Sunburst Brake Wheel with Double Roller Kits

NOW AVAILABLE IN CHROME!

SKU	Ladder Width	Color
QG.210.02	16"	Satin Nickel
QG.210.03	16"	Hamm. Antique Brass
QG.210.04	16"	Chrome
QG.210.06B	16"	Brushed Satin Brass
QG.210.07	16"	Oil Rubbed Bronze
QG.210.08	16"	Black
QG.210-20.02	20"	Satin Nickel
QG.210-20.03	20"	Hamm. Antique Brass
QG.210-20.04	20"	Chrome
QG.210-20.06B	20"	Brushed Satin Brass
QG.210-20.07	20"	Oil Rubbed Bronze
QG.210-20.08	20"	Black



Sunburst Brake Wheel with Single Roller Kits

NOW AVAILABLE IN CHROME!

SKU	Ladder Width	Color
QG.510.02	16"	Satin Nickel
QG.510.03	16"	Hamm. Antique Brass
QG.510.04	16"	Chrome
QG.510.06B	16"	Brushed Satin Brass
QG.510.07	16"	Oil Rubbed Bronze
QG.510.08	16"	Black
QG.510-20.02	20"	Satin Nickel
QG.510-20.03	20"	Hamm. Antique Brass
QG.510-20.04	20"	Chrome
QG.510-20.06B	20"	Brushed Satin Brass
QG.510-20.07	20"	Oil Rubbed Bronze
QG.510-20.08	20"	Black



Sunburst Brake Wheel with Curved Track Roller Kits

SKU	Ladder Width	Color
QG.710.02	16"	Satin Nickel
QG.710.03	16"	Hamm. Antique Brass
QG.710.07	16"	Oil Rubbed Bronze
QG.710.08	16"	Black
QG.710-20.02	20"	Satin Nickel
QG.710-20.03	20"	Hamm. Antique Brass
QG.710-20.07	20"	Oil Rubbed Bronze
QG.710-20.08	20"	Black



Contemporary Wheel with Double Roller Kits

SKU	Ladder Width	Color
QG.220.02	16"	Satin Nickel
QG.220.03	16"	Hamm. Antique Brass
QG.220.06B	16"	Brushed Satin Brass
QG.220.07	16"	Oil Rubbed Bronze
QG.220.08	16"	Black
QG.220-20.02	20"	Satin Nickel
QG.220-20.03	20"	Hamm. Antique Brass
QG.220-20.06B	20"	Brushed Satin Brass
QG.220-20.07	20"	Oil Rubbed Bronze
QG.220-20.08	20"	Black



Contemporary Wheel with Single Roller Kits

SKU	Ladder Width	Color
QG.520.02	16"	Satin Nickel
QG.520.03	16"	Hamm. Antique Brass
QG.520.06B	16"	Brushed Satin Brass
QG.520.07	16"	Oil Rubbed Bronze
QG.520.08	16"	Black
QG.520-20.02	20"	Satin Nickel
QG.520-20.03	20"	Hamm. Antique Brass
QG.520-20.06B	20"	Brushed Satin Brass
QG.520-20.07	20"	Oil Rubbed Bronze
QG.520-20.08	20"	Black



Contemporary Wheel with Curved Track Roller Kits

SKU	Ladder Width	Color
QG.720.02	16"	Satin Nickel
QG.720.03	16"	Hamm. Antique Brass
QG.720.07	16"	Oil Rubbed Bronze
QG.720.08	16"	Black
QG.720-20.02	20"	Satin Nickel
QG.720-20.03	20"	Hamm. Antique Brass
QG.720-20.07	20"	Oil Rubbed Bronze
QG.720-20.08	20"	Black



Contemporary Brake Wheel with Double Roller Kits

SKU	Ladder Width	Color
QG.240.02	16"	Satin Nickel
QG.240.06B	16"	Brushed Satin Brass
QG.240.07	16"	Oil Rubbed Bronze
QG.240.08	16"	Black
QG.240-20.02	20"	Satin Nickel
QG.240-20.06B	20"	Brushed Satin Brass
QG.240-20.07	20"	Oil Rubbed Bronze
QG.240-20.08	20"	Black



Contemporary Brake Wheel with Single Roller Kits

SKU	Ladder Width	Color
QG.540.02	16"	Satin Nickel
QG.540.06B	16"	Brushed Satin Brass
QG.540.07	16"	Oil Rubbed Bronze
QG.540.08	16"	Black
QG.540-20.02	20"	Satin Nickel
QG.540-20.06B	20"	Brushed Satin Brass
QG.540-20.07	20"	Oil Rubbed Bronze
QG.540-20.08	20"	Black



Contemporary Brake Wheel with Curved Track Roller Kits

SKU	Ladder Width	Color
QG.740.02	16"	Satin Nickel
QG.740.07	16"	Oil Rubbed Bronze
QG.740.08	16"	Black
QG.740-20.02	20"	Satin Nickel
QG.740-20.07	20"	Oil Rubbed Bronze
QG.740-20.08	20"	Black

3 Select a Wood Ladder

Each ladder is unassembled, unfinished, sanded to 120-grit, flat-cut, has pre-drilled holes for step fasteners, has dadoed sides for steps, and is ready to finish/assemble.



Standard 16" Ladder

Our original Rolling Library Ladder. Great for tight spaces.

SKU	Wood Species
8' Ladder	
QG.6008.CH	Cherry
QG.6008.MA	Maple
QG.6008.MA-PF	Maple (prefinish)
QG.6008.RO	Red Oak
QG.6008.RO-PF	Red Oak (prefinish)
QG.6008.WA	Walnut
9' Ladder	
QG.6009.CH	Cherry
QG.6009.MA	Maple
QG.6009.MA-PF	Maple (prefinish)
QG.6009.RO	Red Oak
QG.6009.RO-PF	Red Oak (prefinish)
QG.6009.WA	Walnut
10' Ladder	
QG.6010.CH	Cherry
QG.6010.MA	Maple
QG.6010.RO	Red Oak
QG.6010.WA	Walnut



Wide 20" Ladder

A wider ladder for added stability, space, and comfort.

SKU	Wood Species
8' Ladder	
QG.6008-20.CH	Cherry
QG.6008-20.MA	Maple
QG.6008-20.RO	Red Oak
QG.6008-20.WA	Walnut
9' Ladder	
QG.6009-20.CH	Cherry
QG.6009-20.MA	Maple
QG.6009-20.RO	Red Oak
QG.6009-20.WA	Walnut
10' Ladder	
QG.6010-20.CH	Cherry
QG.6010-20.MA	Maple
QG.6010-20.RO	Red Oak
QG.6010-20.WA	Walnut

NEW



Wide 20" Integrated Ladder with Built-In Handles

A wider ladder with handles built into the side rails for added stability with style.

SKU	Wood Species
8' Ladder	
QG.6008-20.CH-H	Cherry
QG.6008-20.MA-H	Maple
QG.6008-20.RO-H	Red Oak
QG.6008-20.WA-H	Walnut
9' Ladder	
QG.6009-20.CH-H	Cherry
QG.6009-20.MA-H	Maple
QG.6009-20.RO-H	Red Oak
QG.6009-20.WA-H	Walnut
10' Ladder	
QG.6010-20.CH-H	Cherry
QG.6010-20.MA-H	Maple
QG.6010-20.RO-H	Red Oak
QG.6010-20.WA-H	Walnut

Aluminum Step Tread



Custom Wood Ladders

*Ladders above 8' requires the purchase of additional step supports.

Wood Species	Up to 8'	Up to 9'	Up to 10'	Up to 11'	Up to 12'	Up to 13'	Up to 14'
Original Design Without Handles							
Alder (16")	\$889	\$988	\$1,105				
Alder (20")	\$1,042	\$1,173	\$1,301				
Birch-White (16")	\$633	\$738	\$816				
Birch-White (20")	\$774	\$864	\$959				
Cherry (16")	\$793	\$888	\$982	\$957	\$1,057	\$1,285	\$1,357
Cherry (20")	\$820	\$935	\$1,007	\$1,057	\$1,186	\$1,400	\$1,515
Hickory (16")	\$685	\$767	\$848				
Hickory (20")	\$800	\$899	\$996				
Maple (16")	\$694	\$773	\$835	\$885	\$985	\$1,200	\$1,350
Maple (20")	\$729	\$810	\$892	\$1,015	\$1,145	\$1,371	\$1,515
African Mahogany (16")	\$1,364	\$1,530	\$1,696				
African Mahogany (20")	\$1,493	\$1,635	\$1,841				
Red Oak (16")	\$554	\$621	\$684	\$685	\$742	\$914	
Red Oak (20")	\$592	\$657	\$722	\$785	\$870	\$1,022	
White Oak* (16")	\$1,031	\$1,155	\$1,279				
White Oak* (20")	\$1,210	\$1,339	\$1,509				
Walnut (16")	\$1,275	\$1,430	\$1,584				
Walnut (20")	\$1,336	\$1,549	\$1,750				
With Built-In Handles (NEW)							
Alder (20")	\$1,584	\$1,711	\$1,916				
Birch-White (20")	\$1,312	\$1,402	\$1,575				
Cherry (20")	\$1,339	\$1,473	\$1,623				
Hickory (20")	\$1,339	\$1,438	\$1,611				
Maple (20")	\$1,325	\$1,405	\$1,573				
African Mahogany (20")	\$2,032	\$2,194	\$2,457				
Oak-Red (20")	\$1,131	\$1,175	\$1,337				
Oak-White* (20")	\$1,805	\$1,955	\$2,190				
Walnut (20")	\$2,119	\$2,406	\$2,580				

* Quarter Sawn

Other wood species available. Visit putnamrollingladder.com or call to see pricing and lead time.



Step Grip For Ladder Steps

Measures 3" x 13" with 1/4" radius corners. Should be installed after the ladder is finished.

SKU	Color
QG.61	Clear

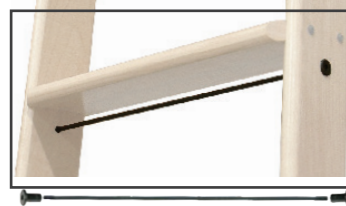

Additional Step Supports - for Custom Ladders and Ladders over 8'

These additional step support rods are only needed when ordering Quiet Glide ladders over 8' tall. If you're building your own ladder, get one support rod per step. Fasteners are included.

SKU	Finish	Width
QG.620.02	Satin Nickel	16"
QG.620-20.02	Satin Nickel	20"
QG.620.04	Chrome	16"
QG.620-20.04	Chrome	20"
QG.620.06B	Brushed Satin Brass	16"
QG.620-20.06B	Brushed Satin Brass	20"
QG.620.08	Black	16"
QG.620-20.08	Black	20"

Available in Brushed Satin Brass and Black:



SKU	Width	Finish
QG.6400-20.01.08	20"	Black
QG.6400-20.01.06S	20"	Brushed Satin Brass
QG.6400.01.08	16"	Black
QG.6400.01.06S	16"	Satin Brass



Steam-Bent Solid Wood Hand Rails

Unfinished, sanded to 120grit, and has pre-drilled assembly holes. Sold in pairs. Specify for Black or Satin Nickel, or Brushed Satin Brass fasteners (included).

SKU	Wood Species
QG.6309.CH	Cherry
QG.6309.HC	Hickory
QG.6309.MA	Maple
QG.6309.RO	Red Oak
QG.6309.WA	Walnut
QG.6309.WO*	White Oak

*Quarter Sawn

4 Select Track Components

Straight Track - Four Different Lengths

SKU	Length	Finish
QG.4003.02	3'	Satin Nickel
QG.4003.04	3'	Chrome
QG.4003.06B	3'	Brushed Satin Brass
QG.4003.07	3'	Oil Rubbed Bronze
QG.4003.08	3'	Black
QG.4004.02	4'	Satin Nickel
QG.4004.03	4'	Hamm. Antique Brass
QG.4004.04	4'	Chrome
QG.4004.07	4'	Oil Rubbed Bronze
QG.4004.08	4'	Black
QG.4006.02	6'	Satin Nickel
QG.4006.03	6'	Hamm. Antique Brass
QG.4006.04	6'	Chrome
QG.4006.07	6'	Oil Rubbed Bronze
QG.4006.08	6'	Black
QG.4008.02	8'	Satin Nickel
QG.4008.03	8'	Hamm. Antique Brass
QG.4008.07	8'	Oil Rubbed Bronze
QG.4008.08	8'	Black

Curved Tracks

Curved tracks are not compatible with all upper hook style hardware. Use only the curved track roller style hardware when building a ladder application with a curved track.

135-Degree Curved Track



SKU	Finish
QG.40CRV135.02	Satin Nickel
QG.40CRV135.03	Hammered Antique Brass
QG.40CRV135.07	Oil Rubbed Bronze
QG.40CRV135.08	Black

90-Degree Curved Track



SKU	Finish
QG.40CRV.02	Satin Nickel
QG.40CRV.03	Hammered Antique Brass
QG.40CRV.07	Oil Rubbed Bronze
QG.40CRV.08	Black

90-Degree Curved Track

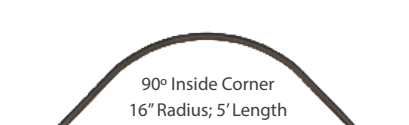

SKU	Finish
QG.40CRV16.02	Satin Nickel
QG.40CRV16.03	Hamm. Antique Brass
QG.40CRV16.07	Oil Rubbed Bronze
QG.40CRV16.08	Black

Custom-bent tracks are available.

90° Outside Corner



90-Degree Outside Curved Track*

SKU
QG.40CRV-05.02
QG.40CRV-05.03
QG.40CRV-05.07
QG.40CRV-05.08

***YOU MUST BUY BOTH THE TRACK AND SWIVEL TOP LADDER ASSEMBLY**

See Page 24 for Top Mount Options.

Track Connector for Joining Round Tracks Together

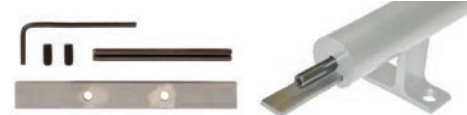

SKU	Size
QG.41	1/2" x 1/8" bar

Thread Tap Accessory

Accessory used to make threads at the end of track pieces for end caps. Included in Kits.



SKU	Size
QG.TAP1420	1/4" x 20 tap

Standard End Cap Kit for Round Track



Made out of solid steel. Kit includes:
- 2 Caps (1 1/4" diameter)
- 2 Fastening bolts (1/4" #20 x 18mm)

SKU	Finish
QG.40.02	Satin Nickel
QG.40.03*	Hammered Antique Brass
QG.40.04	Chrome
QG.40.06B	Brushed Satin Brass
QG.40.07	Oil Rubbed Bronze
QG.40.08	Black

Ball End Cap Kit for Round Track



Made out of aluminum. Ball cap measures 1 1/2" dia. and has a 1/4-20 screw. Each kit includes 2 ball caps.

SKU	Finish
QG.401.02	Satin Nickel
QG.401.03	Hammered Antique Brass
QG.401.07	Oil Rubbed Bronze
QG.401.08	Black

Steel Track-Mounted Ladder Stop



For use with the Single Roller Ladder Hardware. Sold individually. Stops are adjustable and can be placed anywhere along the length of the track. Fasteners are included.

SKU	Color
NT.1404.02	Satin Nickel
NT.1404.07	Oil Rubbed Bronze
NT.1404.08	Black

Wall-Mounted Bracket for Round Track

Choose brackets based on the top roller or hook choice you made (in Step 1). Sold as each. Screws are included. These brackets are used to mount the round track to the mounting surface. You will need 1 bracket for every 32", or 4 brackets for an 8' track. Wall brackets must be mounted securely into solid wood surface.

See Page 21 for our NEW Ceiling Mount options that work for both Rolling Ladders and Barn Doors!



Vertical Rolling/Swivel Bracket
For use with Double Rollers and Curved Track Rollers.

SKU	Finish
QG.201.02	Satin Nickel
QG.201.03	Hamm. Antique Brass
QG.201.04	Chrome
QG.201.06B	Brushed Satin Brass
QG.201.07	Oil Rubbed Bronze
QG.201.08	Black



Vertical Hook Bracket
For use with Single Roller top rollers.

SKU	Finish
QG.301.02	Satin Nickel
QG.301.03	Hamm. Antique Brass
QG.301.04	Chrome
QG.301.06B	Brushed Satin Brass
QG.301.07	Oil Rubbed Bronze
QG.301.08	Black



Horizontal Rolling/Swivel Bracket
For use with Double Roller and Curved Track Rollers.

SKU	Finish
QG.202.02	Satin Nickel
QG.202.03	Hamm. Antique Brass
QG.202.04	Chrome
QG.202.06B	Brushed Satin Brass
QG.202.07	Oil Rubbed Bronze
QG.202.08	Black



Horizontal Hook Bracket
For use with Single Roller top rollers.

SKU	Finish
QG.302.02	Satin Nickel
QG.302.03	Hammered Antique Brass
QG.302.04	Chrome
QG.302.06B	Brushed Satin Brass
QG.302.07	Oil Rubbed Bronze
QG.302.08	Black

Classic No.1 & Step Products

**PUTNAM
CLASSIC**

Nº1

To design your dream ladder, visit: putnamrollingladder.com



Step Stool

Name	Species
PL.29.RO	Red Oak



Painters Ladder

Name	Species
PL.150-36.RO	Red Oak



Pivot Ladder



Pivot Ladder Wood Species and Hardware Options:

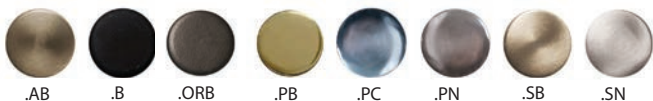

SKU	Finish
Maple	
PL.100.01-MA.AB	Antique Brass
PL.100.01-MA.BK	Black
PL.100.01-MA.ORB	Oil Rubbed Bronze
PL.100.01-MA.PB	Polished Brass
PL.100.01-MA.PC	Polished Chrome
PL.100.01-MA.PN	Polished Nickel
PL.100.01-MA.SB	Satin Brass
PL.100.01-MA.SN	Satin Nickel
Red Oak	
PL.100.01-RO.AB	Antique Brass
PL.100.01-RO.BK	Black
PL.100.01-RO.ORB	Oil Rubbed Bronze
PL.100.01-RO.PB	Polished Brass
PL.100.01-RO.PC	Polished Chrome
PL.100.01-RO.PN	Polished Nickel
PL.100.01-RO.SB	Satin Brass
PL.100.01-RO.SN	Satin Nickel
Walnut	
PL.100.01-WA.AB	Antique Brass
PL.100.01-WA.BK	Black
PL.100.01-WA.ORB	Oil Rubbed Bronze
PL.100.01-WA.PB	Polished Brass
PL.100.01-WA.PC	Polished Chrome
PL.100.01-WA.PN	Polished Nickel
PL.100.01-WA.SB	Satin Brass
PL.100.01-WA.SN	Satin Nickel

SKU	Finish
Cherry	
PL.100.01-CH.AB	Antique Brass
PL.100.01-CH.BK	Black
PL.100.01-CH.ORB	Oil Rubbed Bronze
PL.100.01-CH.PB	Polished Brass
PL.100.01-CH.PC	Polished Chrome
PL.100.01-CH.PN	Polished Nickel
PL.100.01-CH.SB	Satin Brass
PL.100.01-CH.SN	Satin Nickel
Mahogany	
PL.100.01-MG.AB	Antique Brass
PL.100.01-MG.BK	Black
PL.100.01-MG.ORB	Oil Rubbed Bronze
PL.100.01-MG.PB	Polished Brass
PL.100.01-MG.PC	Polished Chrome
PL.100.01-MG.PN	Polished Nickel
PL.100.01-MG.SB	Satin Brass
PL.100.01-MG.SN	Satin Nickel
White Oak	
PL.100.01-WO.AB	Antique Brass
PL.100.01-WO.BK	Black
PL.100.01-WO.ORB	Oil Rubbed Bronze
PL.100.01-WO.PB	Polished Brass
PL.100.01-WO.PC	Polished Chrome
PL.100.01-WO.PN	Polished Nickel
PL.100.01-WO.SB	Satin Brass
PL.100.01-WO.SN	Satin Nickel

NEW ALTA & Log Ladders!



ALTA



Experience the perfect blend of style and functionality with ALTA. ALTA features a fastener-less contemporary look, sturdy aluminum rails with pre-finished wooden steps. ALTA ladders are custom made.

To design your dream ladder, visit: putnamrollingladder.com



Stationary ladder crafted from American pine that can be customized to any height between 3'-10'. Available in Natural Solid Pine with a clear, whitewash, or solid white finish.



Professionally preassembled, including two Quiet Glide® stationary mounting brackets that allow for climbing or stored positions.

log

Meadow Lane



Make use of wasted space and reach new heights in your interior design with a top hook library ladder! We tailor our ladders to meet the perfect budget, aesthetics, and functionality you need for your unique application. Take your decor to the next level while creating easy access to the hard-to-reach areas of your home or business.

SKU	Finish
ML.300.02	Satin Nickel
ML.300.06	Polished Brass
ML.300.07	Oil-Rubbed Bronze
ML.300.08	Black



Ordering Notes:

*For 107" ladder, an additional Step Support Kit must be purchased

*If ordering the ladder WITHOUT the Ladder Kit (above), one Step Support Kit per step is required. 7 for the 92" and 8 for the 107" ladder.

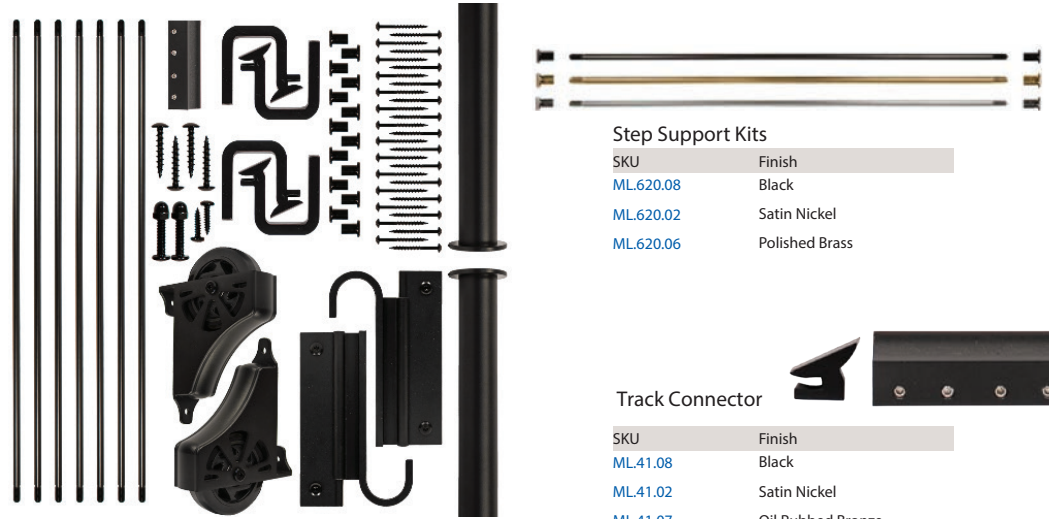

Step Support Kits

SKU	Finish
ML.620.08	Black
ML.620.02	Satin Nickel
ML.620.06	Polished Brass

Track Connector

SKU	Finish
ML.41.08	Black
ML.41.02	Satin Nickel
ML.41.07	Oil Rubbed Bronze
ML.41.06	Polished Brass

Track Bracket



SKU	Finish
ML.301.08	Black
ML.301.02	Satin Nickel
ML.301.07	Oil Rubbed Bronze
ML.301.06	Polished Brass

4' Tracks



SKU	Finish
ML.4004.08	Black
ML.4004.02	Satin Nickel
ML.4004.07	Oil Rubbed Bronze
ML.4004.06	Polished Brass

End Caps



SKU	Finish
ML.40.08	Black
ML.40.02	Satin Nickel
ML.40.07	Oil Rubbed Bronze
ML.40.06	Polished Brass

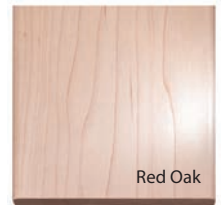
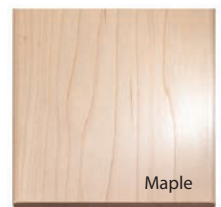

Ladders

SKU	Wood Species
92" Ladder	
ML.6092.MA	Maple
ML.6092.MA-PF	Maple - prefinished
ML.6092.RO	Red Oak
ML.6092.RO-PF	Red Oak - prefinished
107" Ladder	
ML.6107.MA	Maple
ML.6107.MA-PF	Maple - prefinished
ML.6107.RO	Red Oak
ML.6107.RO-PF	Red Oak - prefinished

Design your DREAM Rolling Ladder with our NEW Ladder Configurator at www.putnamrollingladder.com

Classic No. 1

Quiet Glide

ALTA

Meadow Lane

LOG



DESIGN YOUR CLASSIC NO. 1 LADDER

[Save Design](#) [Load Saved Design](#) [Reset Current Design](#) [Share](#)

1. Hardware & Finish Color ▼

FINISH

Available in 8 colors. Choose the finish that best matches your project.



Antique Brass



Black



Oil Rubbed
Bronze



Polished Brass



Polished Chrome



Polished Nickel



Satin Brass



Satin Nickel

2. Wheel & Roller ▼

3. Ladder ▼

(Mounting Track Height)

4. Track and Mounting Hardware ▼

I understand that this is a custom ladder. Check to read and agree to the terms.

Add to Cart - \$0.00

Share



Start designing today!

See what Putnam Rolling Ladder has to offer!



Request a 2024 Putnam Ladder Look Book

by emailing service@putnamrollingladder.com or calling 1-800-882-0009
(M-F 8:00am-4:30pm CST)

Or view our **online** 2024 Putnam Ladder Look Book by scanning the QR Code below!





Custom Service Hardware®

PUTNAM
ROLLING LADDERS

EST. 1905

📍 N169W21008 Meadow Ln.
Jackson WI, 53037

☎️ (262) 365-7960

🌐 cshardware.com

🌐 putnamrollingladder.com

