

# **320 EPOXY EURO SPECS**

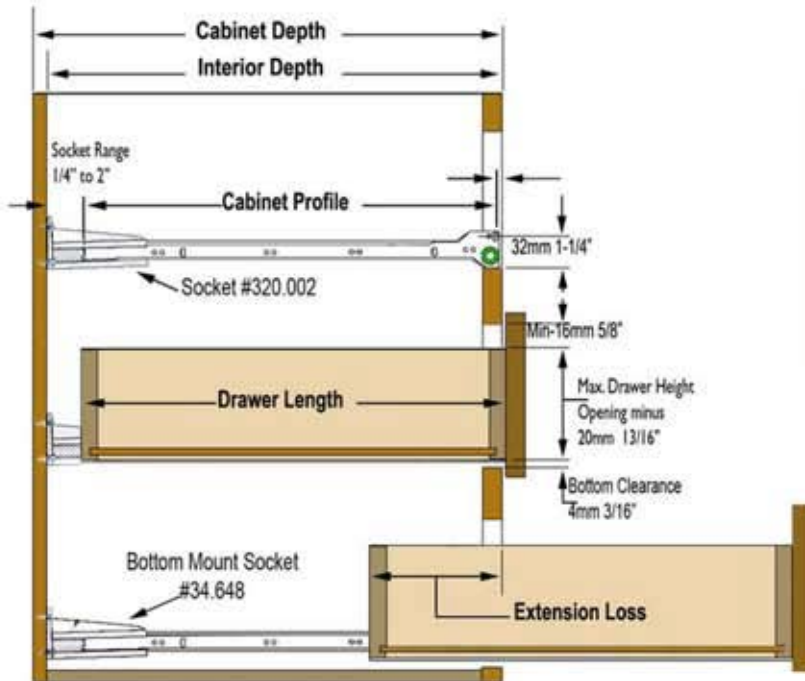

# 320 Epoxy Euro Drawer Slides

## Face Frame Cabinet Installation



Use: #6 x 1/2" Truss Head Screws for Sockets  
 Use: #6 x 5/8" Under Cut Flat Head Screws for Mounting Slides.

## Frameless Cabinet Installation

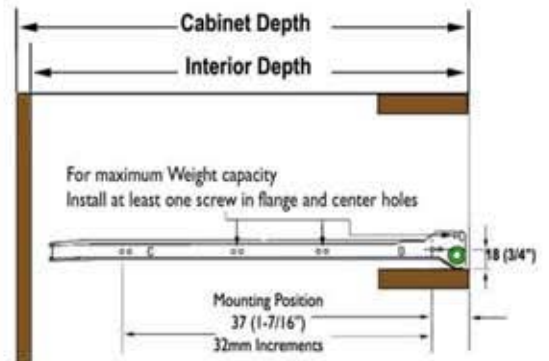

## Drawer Profile Mounting

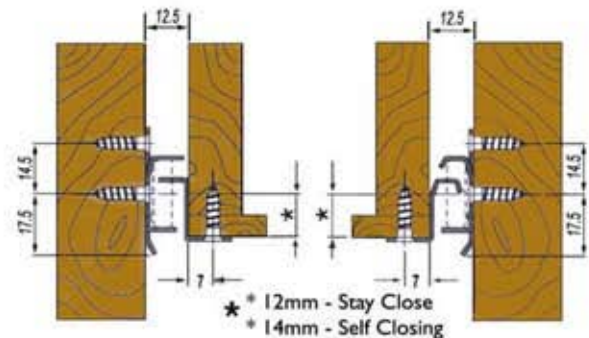
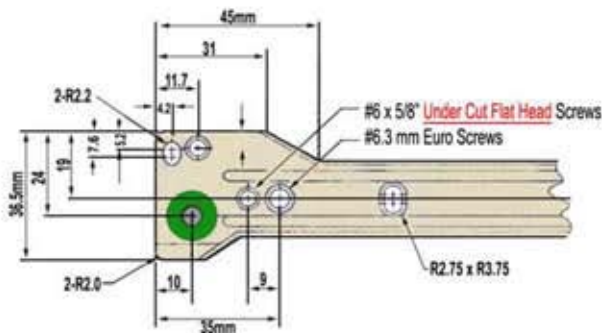
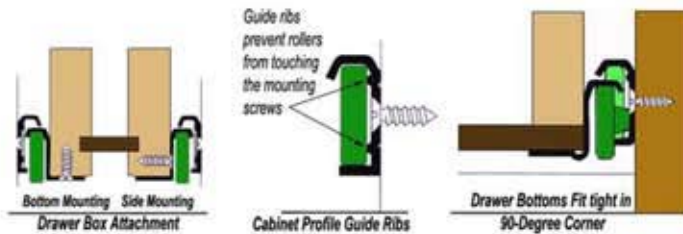
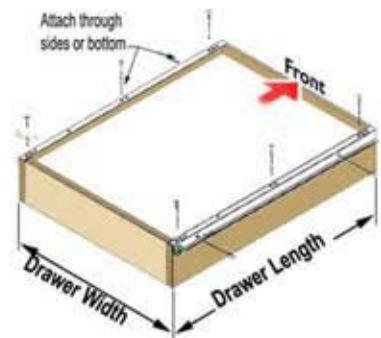

# 320 Epoxy Euro Drawer Slides

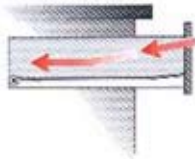

Sockets available

**Important:** The self close and the stay close design lowers the drawer into the closed position. Consult the minimum reveal table to make sure the drawer fronts clears the countertop overhang when the drawer opens.

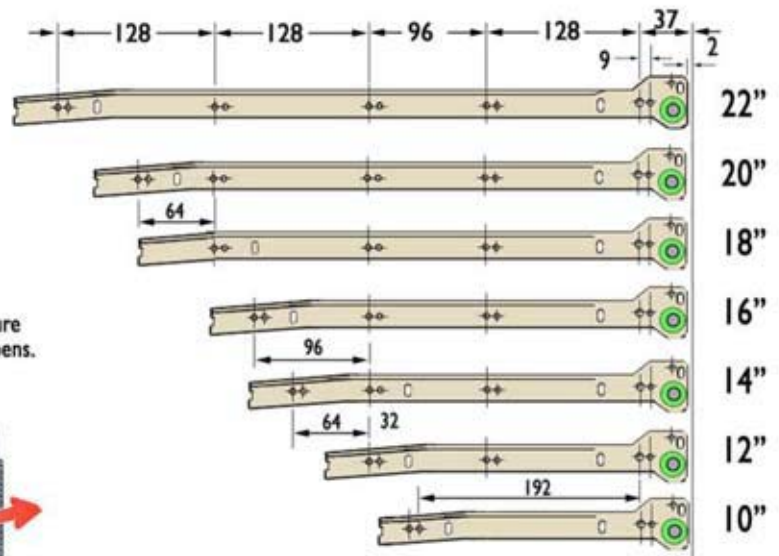
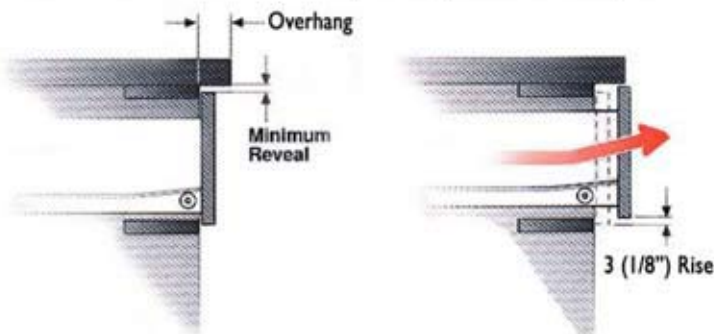

Overhang	16 (5/8")	32 (1 1/4")	48 (1 7/8")
Minimum Reveal	1 (1/32)	2 (2/32)	3 (1/8)