



# CABINETS

# Custom Service Hardware®

*Built on service, since 1977*

At Custom Service Hardware, partnership goes beyond a promise, it's the foundation of how we serve builders, designers, contractors, and homeowners every day. As a proud Midwest company with over four decades of experience, we deliver reliability and genuine community values to every collaboration.

We know that creating exceptional spaces starts with having the right choices and uncompromising quality. That's why we offer a vast selection of premium cabinetry from trusted vendors, empowering you to achieve your design goals with flexibility and confidence. We maintain a commitment to quality in all aspects, from customized drawers to resilient finishes, ensuring an exceptional final result for your space.

Our partnerships are built for longevity. We prioritize clear communication, collaboration, and quick responses aligned to your needs. With technical expertise and genuine connection, we help you manage challenges and provide creative solutions. Custom Service Hardware is more than a supplier; we're your dependable partner now and into the future.



# Our Cabinet Collection:

## Build Your Dream Space

One Detail at a Time

4

## Fabuwood

Pre-Assembled

18

## TA

Ready-to-Assemble

34

## JSI

Ready-to-Assemble or Pre-Assembled

40

## Legend \*Made in USA

Pre-Assembled

52

## Open Air \*Made in USA

Outdoor, Pre-Assembled

62

## Conestoga \*Made in USA

Semi-Custom, Ready-to-Assemble

72

## Custom Service Hardware

FAQs, Policies & Support

87



# Build Your Dream Space

## START TO FINISH

Build your dream cabinet space from start to finish. From planning and design, to selecting the perfect style, color, and layout, we guide you through every step to make the process smooth and stress-free. While kitchens are often the first place people think of for cabinets, they're so much more versatile—perfect for bathrooms, laundry rooms, home offices, garages, and beyond. Wherever you need storage and style, we'll work with you to create a space that fits your life and brings your vision to reality.



Your personal style is the result of how all the elements in your space come together. Paint sets the mood, hardware adds character, and a backsplash brings in texture. Flooring anchors the space, lighting shapes the atmosphere, and cabinet style defines the overall look. Together, they create a design that's uniquely yours.

Cabinet inserts help maximize space and keep everything organized, giving items like spices, cookware, and pantry goods a dedicated spot. They reduce clutter, make essentials easier to find, and add everyday convenience to your home.



A rolling ladder brings beauty and function to any space, combining timeless style with everyday practicality. Easily reach high shelves in a library, kitchen, pantry, closet, or entryway while adding a touch of sophistication to your décor. With its perfect blend of charm and utility, a Putnam Rolling Ladder enhances organization, efficiency, and style—add one to your home today!

Start Dreaming at [putnamrollingladders.com](https://putnamrollingladders.com)

Your Kitchen Looks  
Better with a Ladder.





*Design your dream ladder today at  
[putnamrollingladder.com](http://putnamrollingladder.com)*

## Kitchen Work Zones

Every kitchen is unique, and the traditional work triangle remains a trusted foundation for creating efficient layouts. Over time, though, the kitchen has evolved far beyond a place for cooking. It has become the central hub of the home—where family and guests gather, share conversations, and spend time together creating memories.

Modern kitchen designs often include additional spaces such as coffee/beverage stations, wet or dry bars, dedicated baking areas, desk or drop zones, and casual hangout spaces. These features reflect the way we live today and can adapt to a household's changing needs.

The work triangle is still an excellent starting point, but it's only the beginning. Building upon this concept allows you to create a customized kitchen that perfectly balances functionality, family life, and entertaining.



### Parallel Layout

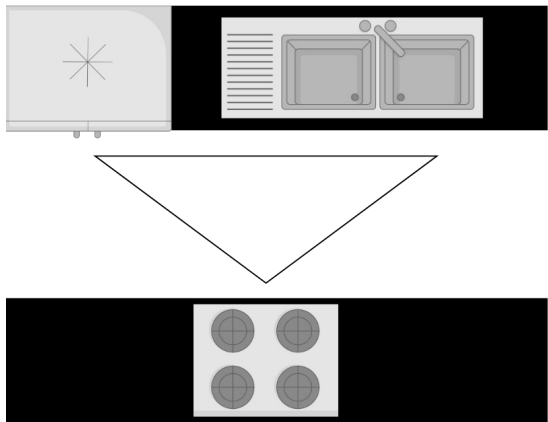

When designing your kitchen, it's a great idea to start with one of these foundational layouts, which follow the kitchen triangle — the ideal connection between your sink, stove, and refrigerator. These three points should form a clear, unobstructed path to minimize movement and improve workflow.

### Island Layout

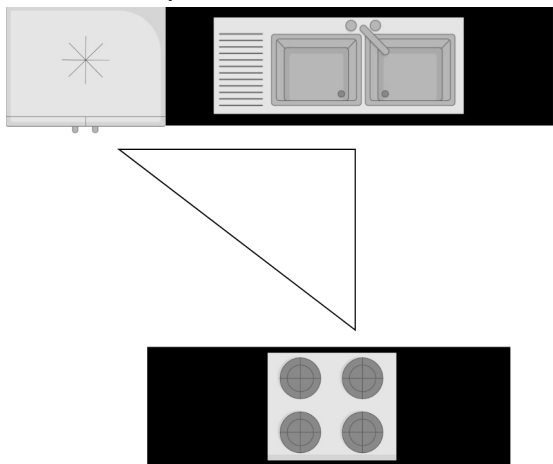

### G-Shaped Layout

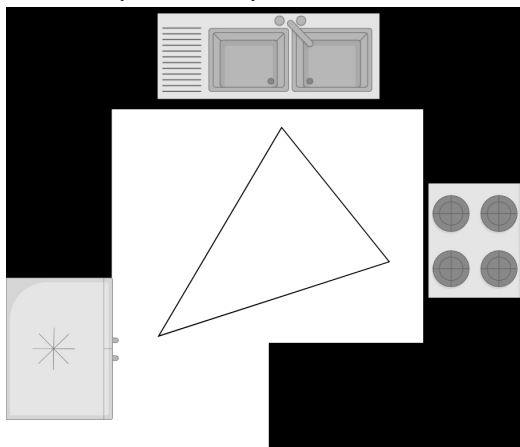

### U-Shaped Layout

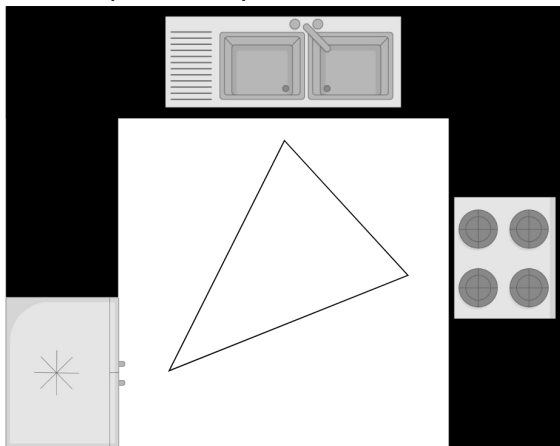

### L-Shaped Layout

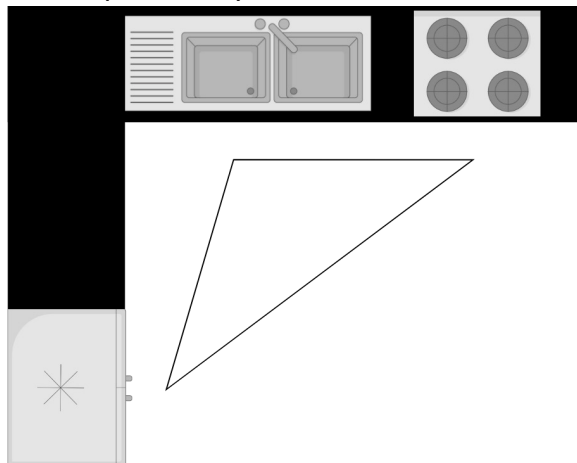

### Straight Layout

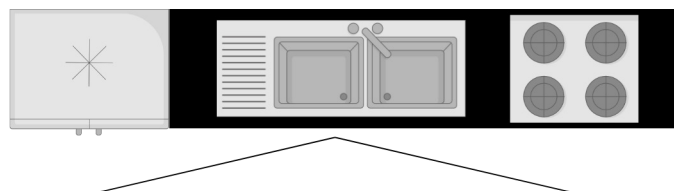



*Fabuwood, Allure Galaxy, Forest Green*



*Fabuwood, Illume Catalina, Carbone Matte*

# Cabinets Beyond the Kitchen

Style & storage for every room in your home.



Fabuwood, Allure Galaxy, Frost



Fabuwood, Allure Galaxy, Izel Blue



*Fabuwood, Allure Fusion, Orchid Purple & Allure Galaxy, Frost*



# Organized & On Point

CSH delivers complete cabinet and organization solutions designed to enhance both function and style.

- 1 Waste Pull-Out
- 2 Tilt-Out Tray
- 3 Corner Cabinet Optimizers
- 4 Double Tier Silverware Drawer
- 5 Roll-Out Drawers
- 6 Rolling Ladder  
*Putnam Rolling Ladder®,  
Quiet Glide®, Black, Maple*
- 7 Floating Shelf
- 8 K-Cup Insert
- 9 Spice Insert
- 10 Appliance Lift



# INSERTS



6

7

8

9

10

# Effortless Organization, Everyday Convenience

## Waste Pull-Outs

A kitchen waste pull-out keeps trash discreetly out of sight while maximizing cabinet space. With smooth gliding access and a clean, built-in look, it offers a smart, efficient solution for every day waste management.

1



## Tilt-Out Trays

A tilt-out tray under your kitchen sink turns unused space into handy storage for sponges, brushes, and pan scrapers, keeping counters clear and essentials within reach.

2



## Corner Cabinet Optimizers

Corner cabinet storage optimizes unused space and improves accessibility with solutions like Lazy Susans or pull-out shelves, keeping items organized and easy to reach while boosting overall kitchen storage.

3



## Double Tiered Silverware Drawers

A double-tiered silverware drawer maximizes space by stacking two organized layers, keeping everyday utensils on top and less-used items below for easy access and a clutter-free kitchen.

4



## Roll-Out Drawers

Roll-out drawers enhance storage in kitchens and bathroom vanities by sliding out smoothly for easy access. They minimize clutter, save time, and keep items neatly organized.

5



## Rolling Ladders

A rolling ladder maximizes vertical storage by giving you convenient, easy access to high shelves and hard-to-reach areas. It also adds a touch of style and functionality, transforming your space into something both practical and visually impressive.

6



## Floating Shelves

Showcase kitchen essentials, books, framed photos, and more with floating shelves. They're an ideal solution for storing your items while highlighting your personal style.

7



## Coffee/Tea Organizers

Keep your coffee and tea pods neatly stored and within reach. This space-saving organizer fits perfectly in a drawer or cabinet, helping you maintain a tidy, streamlined kitchen while letting you find your favorite flavor in seconds.

8



## Spice Inserts

A spice drawer keeps every flavor neatly organized and right at your fingertips. No more searching—just grab, sprinkle, and savor in style. Designed to maximize space and keep your kitchen looking clean and efficient.

9



## Appliance Lifts (For full-height door cabinets only)

An appliance lift adds convenience by allowing you to easily store heavy kitchen tools, like stand mixers, out of sight but within easy reach. It also helps maximize counter space while reducing strain from lifting bulky items.

10





Built on craftsmanship and efficiency, Fabuwood is a semi-custom cabinet company with manufacturing rooted in the U.S. and supported by global sourcing. Operating expansive facilities in New Jersey and California, they've become one of America's largest cabinet manufacturers, known for quality, speed and value.

## Fabuwood Pre-Assembled Cabinets + Craftsmanship

### Inside Fabuwood Cabinetry



Fabuwood cabinets meet an industry leading quality standard defined by these twelve standards. Visit [fabuwood.com](http://fabuwood.com) to learn more.

### Grade-A-Materials



To ensure the absolute integrity of our product, each element is carefully selected. We start by choosing only "Grade-A" materials and make no compromises.

### Quality Craftsmanship



Fabuwood cabinets combine exceptional strength with precise craftsmanship, meeting top industry standards for lasting quality.

### Construction



Fabuwood cabinets feature Allure Dovetail and Illume Threespine® construction for lasting strength and durability. They also include Blum's Tandem Plus full-extension glides with compact soft-close hinges for maximum storage and smooth operation.

### Pro-Touch Finishing



Allure and Illume cabinets combine elegant, durable finishes with Fabuwood's sustainable pro-touch technique, ensuring lasting beauty and easy maintenance for years.

### Lead Times/Delivery



Shipping locations:

- \*Newark, NJ
- Los Angeles, CA

Short lead times—most orders ship within 7 to 10 business days. Modifications may add to your lead time.

\*Pick up also available at this location only.



Allure Luna, Frost & Pitch Black  
Euro Timber Range Hood





*Putnam Rolling Ladders®  
Classic No. 1 Ladder,  
Polished Brass, Walnut*

*Allure Luna, Hunter Green*

# Allure Door Styles

## Framed Series



**Galaxy** - Shaker Style



**Luna** - Modern Style



**Fusion** - Transitional Style



**Nexus** - Transitional Style

### STAIN COLORS

**\*COBBLESTONE**  
Warm Gray



(G)

**\*DESERT OAK**  
Satin White Oak Finish



(G) (L)

**\*HORIZON**  
Gray w/Pink Undertone



(G)

**\*KONA**  
Warm Espresso

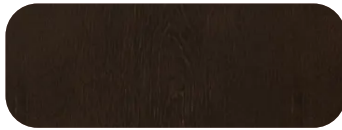

(L) (F)

**\*MOCHA**  
Rich Brown

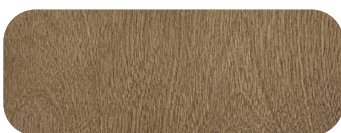

(G)

**\*TIMBER**  
Natural Light Brown

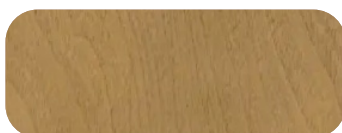

(G) (L) (F)



Allure Galaxy, Dove

PAIN T COLORS

**CABERNET RED**

*Rich Red*



G L F N

**CLOUD WHITE**

*Soft White*



G L F N

**DENIM BLUE**

*Muted Blue*



G L F N

**\*DOVE**

*Soft Off-White*

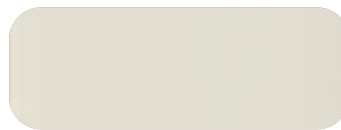

G L F N

**Forest Green**

*Natural Green*



G L F N

**\*FROST**

*Pure White*

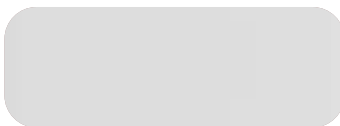

G L F N

**GRAPHITE BLACK**

*Muted Black*



G L F N

**HUNTER GREEN**

*Deep Green*



G L F N

**\*INDIGO**

*Dark Navy*



G L F N

**IZEL BLUE**

*Soft Matte-Blue*



G L F N

**\*LINEN**

*Warm Cream*

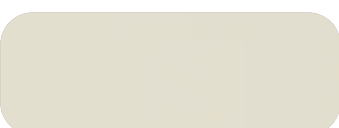

G L F N

**MACADAMIA BEIGE**

*Neutral Beige Tone*



G L F N

**MINT GREEN**

*Pastel Green*



G L F N

**\*NICKEL**

*Soft Gray*



G L F N

**ORCHID PURPLE**

*Soft Pink/Purple*



G L F N

**\*OYSTER**

*Warm Beige-Gray*



G L F N

**PISTACHIO GREEN**

*Earthy Green Tone*



G L F N

**\*PITCH BLACK**

*Black*



G L F N

**SAGE GREEN**

*Muted Soft Green*



G L F N

**\*STONE**

*Warm Greige Tone*

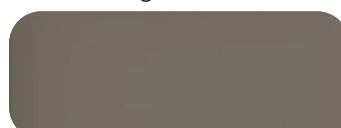

G L F N

Note: Color as it appears in print will vary. For a more accurate view, please order a sample at [cshardware.com](http://cshardware.com)

**\*SIGNATURE COLORS**

Each cabinet door style on the adjacent page has their own signature colors. Scan the QR code on page 25 or reach out to one of our cabinet experts to learn more.

**CUSTOM COLORS AVAILABLE**

Finishes in every paint color offered by Benjamin Moore® or Sherwin Williams®. The only limit is your imagination.



*Allure Galaxy, Cabernet & Mocha*

## Inserts & Accessories

Custom Colors



Floating Shelves



Pull-Out Organizers



Waste Pull-Out



Drawer Inserts/Dividers



2-Tiered Drawers



Note: Accessory images are for reference only and may not reflect Fabuwood Cabinetry door/finish options.

# Allure Cabinet Specifications

Galaxy/Luna/Fusion/Nexus

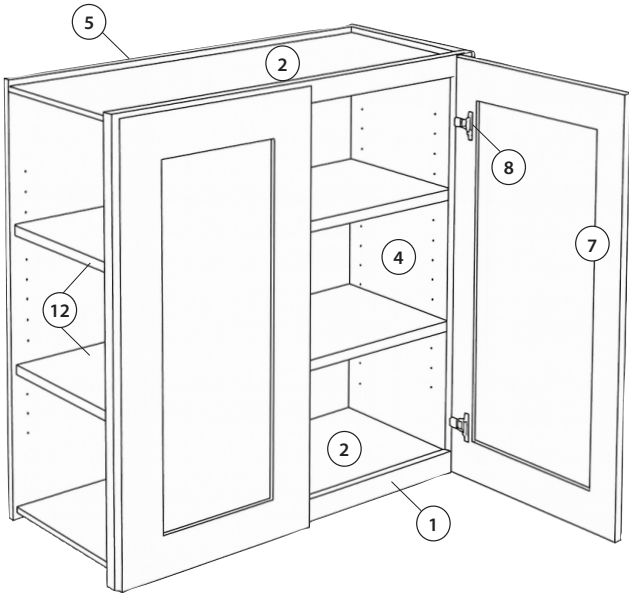

Exterior sides are unfinished and do not match the cabinet face. Specify finished ends for all exposed sides.

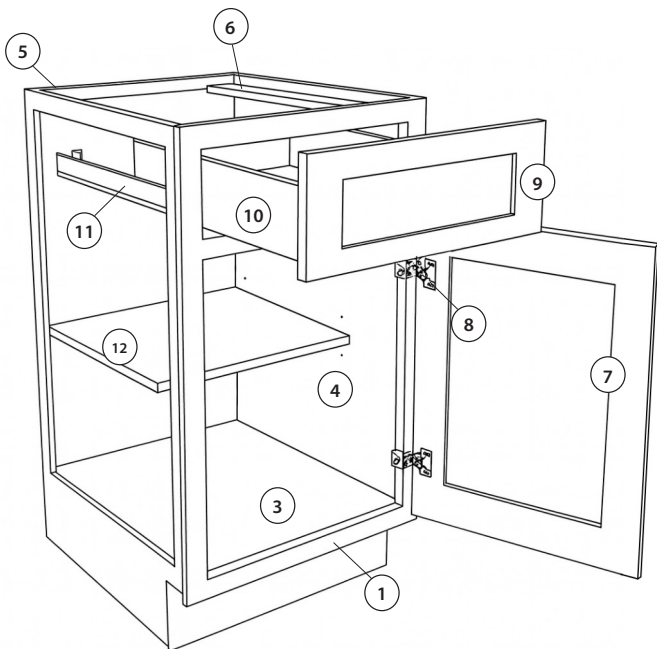

Available, shipping and \*pick up locations:  
Newark, NJ/Los Angeles, CA  
(\*Newark location only)

Lead time:  
Pre-Assembled, 7-10 Business days

More Fabuwood



- 1 **Face Frame**  
- 3/4" solid wood x 1-1/2" wide.
- 2 **Wall Top & Floor Bottom**  
- 1/2" thick plywood.
- 3 **Base Bottom**  
- 1/2" thick plywood.
- 4 **Side Panel**  
- 1/2" thick unfinished plywood, dovetailed into face frame.
- 5 **Back Panel**  
- 1/2" thick veneered plywood back.
- 6 **Panel Beam**  
- 2-1/2" x 1/2" plywood. Panel beams dovetailed into side panels for extra strength and stability.
- 7 **Door Panels, Full Overlay**  
- Full overlay door with mortise & tenon construction.  
- Solid wood frame, with a 3/8" MDF center panel;  
Allure Luna series features a 5/8" MDF center panel.
- 8 **Hinges**  
- Compact clip hinges with quick-release technology, featuring integrated BLUMOTION soft-close, 6-way adjustability, and a 110° opening angle.
- 9 **Drawer Fronts, Full Overlay**  
- 5-piece recessed drawer front with a 3/8" MDF center panel; Allure Luna series features a 5/8" center panel.
- 10 **Drawer Box Construction**  
- 5/8" solid wood dovetail drawer, 3/8" plywood bottom.
- 11 **Drawer Glides**  
- Full-extension soft-close Tandem Plus BLUMOTION concealed drawer glides.
- 12 **Shelving**  
- 3/4" plywood adjustable shelving.

### Additional Notes

- Wood species: Blend of solid woods, plywood & MDF.
- Interior finish: Natural finish.
- Assembly options: Pre-assembled.
- Options available: Bathroom-depth vanities, wood & stainless steel hoods, cabinet inserts, trim, accessories and cabinet modifications. (modifications may add to your lead time)
- CARB 2 Compliant.
- ADA-compliant sizing available, on select styles.



*Allure Fusion, Dove & Denim Blue  
Artisan Walnut Hood*



*Valencia Lavari Vanity, Frost*



*Illume Catalina, Como Ash 2 & Cashmere Matte*



*Fusion Vanity, Shaker Platform with Taper Feet, Denim Blue*

## Hoods Styles & Finishes



**Artisan**  
Walnut (A)



**Arched**  
Oyster (AR)



**Signature**  
Indigo (S)



**Farmhouse**  
Frost (F)



**Euro**  
Horizon (E)



**Z-Line Stainless Steel**  
KF-36

### STAIN COLORS

**COBBLESTONE**  
Warm Gray



(A) (AR) (S) (F) (E)

**HORIZON**  
Gray w/Pink Undertone

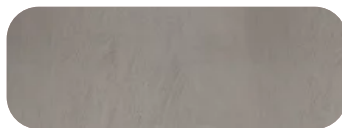

(A) (AR) (S) (F) (E)

**KONA**  
Warm Espresso

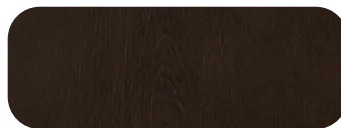

(A) (AR) (S) (F) (E)

**TIMBER**  
Natural Light Brown

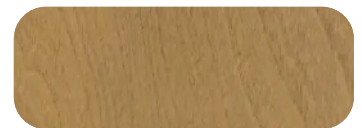

(A) (AR) (S) (F) (E)

### WALNUT

Warm Mocha & Golden Tones w/  
deep wood texture

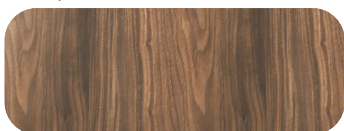

(A) (S)

Express your style with Fabuwoods' diverse range of kitchen hoods, from urban & farmhouse, to stainless steel.

## PAINT COLORS

**DOVE**  
Soft Off-White



(A) (AR) (S) (F) (E)

**FROST**  
Pure White



(A) (AR) (S) (F) (E)

**INDIGO**  
Dark Navy



(A) (AR) (S) (F) (E)

**LINEN**  
Warm Cream



(A) (AR) (S) (F) (E)

**NICKEL**  
Soft Gray



(A) (AR) (S) (F) (E)

**OYSTER**  
Warm Beige-Gray



(A) (AR) (S) (F) (E)

**STONE**  
Warm Greige Tone

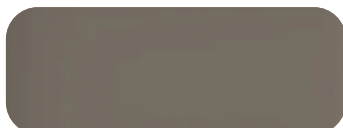

(A) (AR) (S) (F) (E)



Note: Color as it appears in print will vary. For a more accurate view, please order a sample at [cshardware.com](http://cshardware.com)

# Illume Door Styles

## Frameless Series

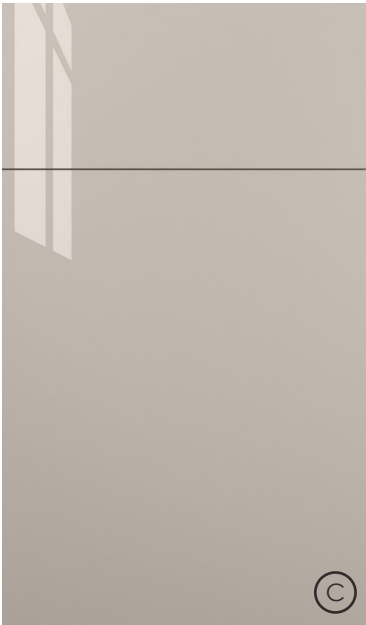

**Catalina** - Modern Style,  
Cashmere, Gloss

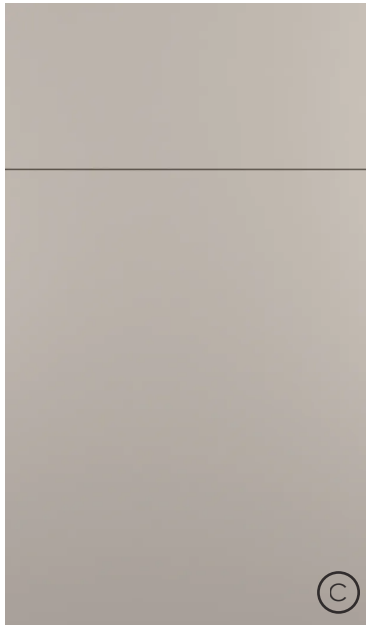

**Catalina** - Modern Style,  
Cashmere, Matte

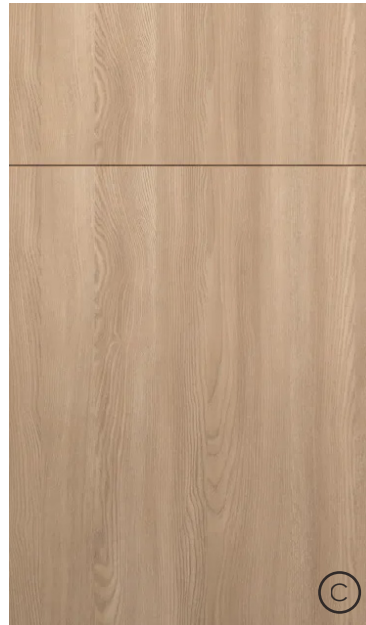

**Catalina** - Modern Style,  
Textured, Como Ash 2



**Tuscany** - Transitional Style,  
Textured, Como Ash 2

### MATTE COLORS

**ANTRACITA**  
Deep Charcoal



(C) (T)

**AQUA MARINA**  
Cool Mint/Misty Jade



(C)

**AZUL INDIGO**  
Deep Ink Blue



(C) (T)

**AZUL MARINO**  
Navy



(C) (T)

**BASALTO**  
Rich Taupe



(C) (T)

**\*BIANCO**  
Luminous White

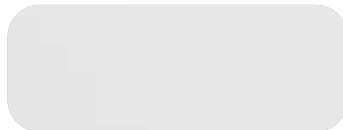

(C)

**BLACK**  
Rich Black



(C)

**BLANCO**  
Crisp Snow-White

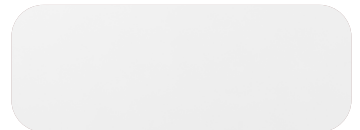

(C) (T)

**\*CARBONE**  
Earthy Gray



(C)

**CASHMERE**  
Creamy Beige



(C) (T)

**GRIS PLOMO**  
Charcoal Gray



(C)

**VERDE SALVIA**  
Moody Gray w/Green Tone



(C) (T)

TEXTURED COLORS

COMO ASH 1

*Soft Greige-Tones*



(C) (T)

\*COMO ASH 2

*Sandy Natural Wood-Tones*



(C) (T)

FRAPPE

*Honey Beige-Tones*



(C) (T)

ICE CREAM

*Creamy Ivory-Tones*



(C)

IDA 1

*Light Oak-Tones*

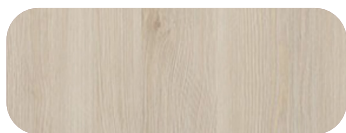

(C) (T)

IDA 2

*Sunlit Caramel-Tones*



(C) (T)

\*MURATTI 1

*Brushed Steel-Tones*

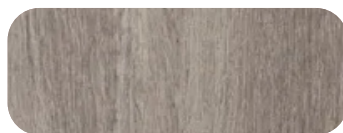

(C) (T)

\*MURATTI 4

*Deep Charcoal-Tones*

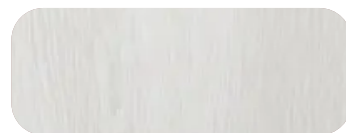

(C) (T)

NOCCE 1

*Soft Honey*

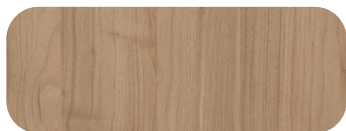

(C) (T)

\*NOCCE 3

*Medium-Toned Brown*



(C) (T)

\*Olmo 3

*Bold Dark Woodgrain*

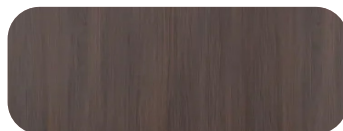

(C) (T)

ROSALES 1

*Soft Walnut-Taupe*



(C) (T)

ROSALES 2

*Warm Caramel*



(C) (T)

ROSALES 3

*Deep Walnut*

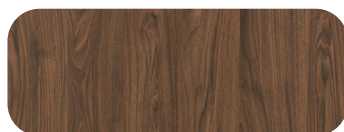

(C) (T)

WOODLINE 1

*Soft Ivory*



(C) (T)

WOODLINE 3

*Espresso/Dark Walnut-Tones*



(C) (T)

WOODLINE 4

*Soft Caramel/Honey-Tones*



(C)

\*Catalina  
Signature  
Colors



*Illume Tuscany, Rosales 2*



Illume Catalina, Grigio Gloss

## GLOSS COLORS

**AQUA MARINA**  
Cool Mint/Misty Jade



**AZUL INDIGO**  
Deep Ink Blue



**AZULE MARINO**  
Navy



**\*BIANCO**  
Luminous White



**BLACK**  
Rich Black



**BLANCO**  
Crisp Snow-White

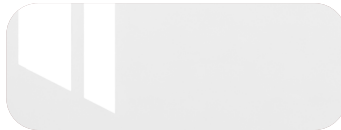

**CASHMERE**  
Creamy Beige



**EUROLINE**  
Charcoal Tones/Linear Lines



**\*GRIGIO**  
Smoky Gray



**GRIS NUBE**  
Misty Gray



**GUAYANA**  
Deep Mahogany-Tones

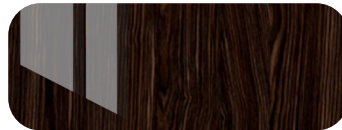

**METALLO 1**  
Muted Gray-Tones



**METALLO 4**  
Charcoal-Tones

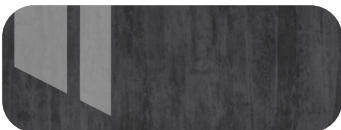

**OLIVO**  
Rich Wood-Tones



**TEXTIL PLATA**  
Warm Taupe/Gray, Woven Pattern



# Illume Frameless Cabinet Specifications

Catalina/Tuscany

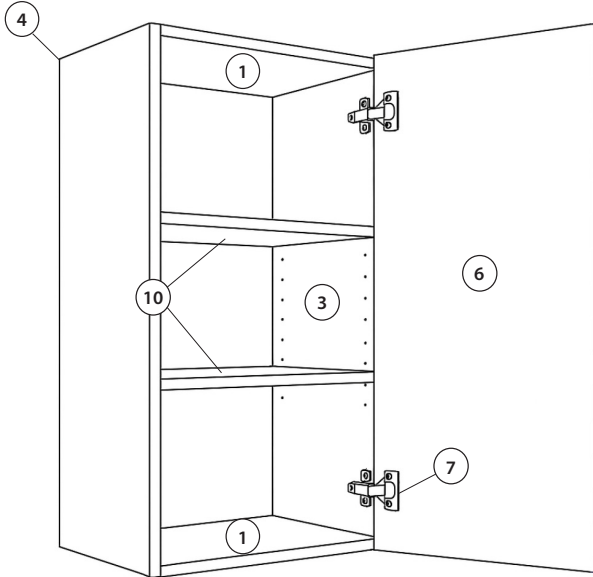

Exterior sides are unfinished and do not match the cabinet face. Specify finished ends for all exposed sides.

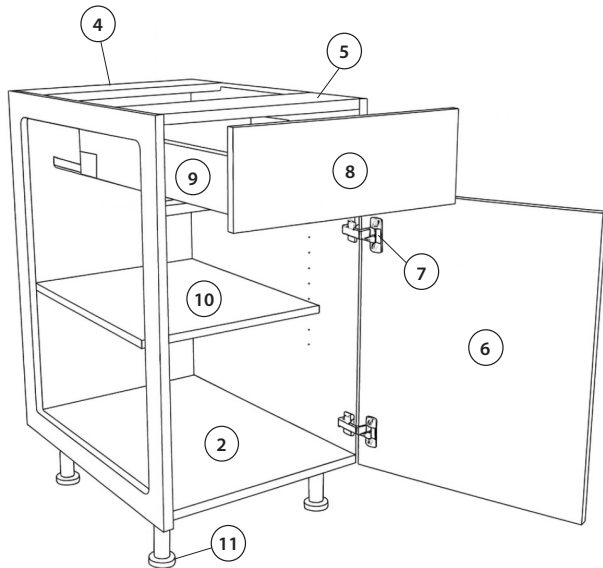

- ① **Wall Top & Floor Bottom**  
- 3/4" engineered furniture board (EFB).
- ② **Base Bottom**  
- 3/4" engineered furniture board (EFB).
- ③ **Side Panel**  
- 3/4" engineered furniture board (EFB).
- ④ **Back Panel**  
- 1/4" engineered furniture board (EFB), with 5/8" hanging rails.
- ⑤ **Panel Beam**  
- 5-1/2" wide panel beams front and rear.
- ⑥ **Door Panels, Full Overlay**  
- 3/4" MDF core slab door.
- ⑦ **Hinges**  
- BLUM concealed clip-on hinges with quick-release technology, featuring integrated BLUMOTION soft-close, 6-way adjustability, and a 110° opening angle.
- ⑧ **Drawer Fronts, Full Overlay**  
- 3/4" MDF core slab drawer.
- ⑨ **Drawer Box Construction**  
- BLUM MERIVOBX premium metal drawer system with indium gray sides and interior, 2 5/8" drawer height.
- ⑩ **Shelving**  
- 3/4" engineered furniture board (EFB) adjustable shelving. Edge-banded with white linen textured laminate.
- ⑪ **Base Feet**  
- Black plastic furniture feet, adjustable from 3-3/4" to 5-3/8".

### Additional Notes

- Wood species: Engineered furniture board (EFB).
- Interior finish: White linen.
- Assembly options: Pre-assembled.
- Options available: Bathroom-depth vanities, wood and stainless steel hoods, cabinet inserts, trim, accessories and cabinet modifications. (modifications may add to your lead time)
- CARB 2 Compliant.

📍 Available, shipping and \*pick up locations:  
Newark, NJ/Los Angeles, CA  
(\*Newark location only)

🚚 Lead time:  
7-10 Business days

More Fabuwood





TA Cabinetry is one of the leading providers of high quality Ready-to-Assemble and semi-custom cabinetry, dedicated to offering affordable and stylish solutions for every home. Founded on the principles of quality affordability, TA Cabinetry has quickly become a trusted name in the industry. TA Cabinetry's mission is to make beautiful and functional kitchen and bath living spaces.

## TA Ready-to-Assemble Cabinets + Craftsmanship

### Inside TA Cabinetry



TA Cabinetry takes pride in its commitment to quality and craftsmanship, guided by the belief that quality should endure for years to come.

### Carefully Selected Standard



The style and design offerings of TA Cabinetry meet diverse customer needs, combining aesthetic appeal with practical functionality.

### Quality Craftsmanship



TA Cabinetry offers factory direct all-wood cabinets that combine affordability with exceptional quality.

### Construction



Each unit delivers custom-level craftsmanship and features—like dovetailed full-extension soft-close drawers, soft-close hinges, and reinforced metal corner brackets—all at an exceptional value.

### Finishing



TA Cabinetry uses a premium multi-step finishing process. Stain and paint finishes receive a durable catalyzed clear topcoat, while glazed finishes are hand-applied and sealed with the same protective coating.

### Lead Times/Delivery



Shipping and pickup locations:

- Charlotte, NC
  - Chicago, IL
  - Columbus, OH
  - Washington, DC
- Most orders ship within 1–2 weeks.



*Timeless Shaker, Gray*  
35





*Doric Black & Timeless Shaker White*

# Door Styles & Colors

## Timeless Shaker Series



White (TSW)

Gray (TSG)

Blue (TSB)

## Doric Series



Beige Gray (DBG)

Charcoal Black (DCB)



Karamel (TSK)

Charcoal Black (TSC)

Dove (TSD)



*Timeless Shaker, Karamel*

## Contemporary Series



Dove White (CDW)

Tuscan Green (CTG)

White Oak (CWO)

## Nostalgic



Slate Brown (NSB)

*Accessories & Inserts Available*

More TA

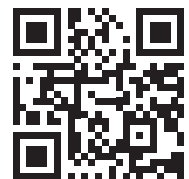



## Cabinet Specifications

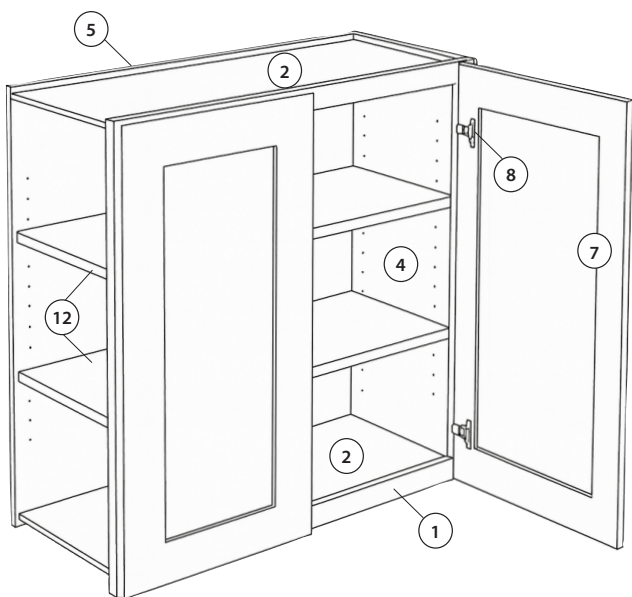

Exterior sides are unfinished and do not match the cabinet face. Specify finished ends for all exposed sides.

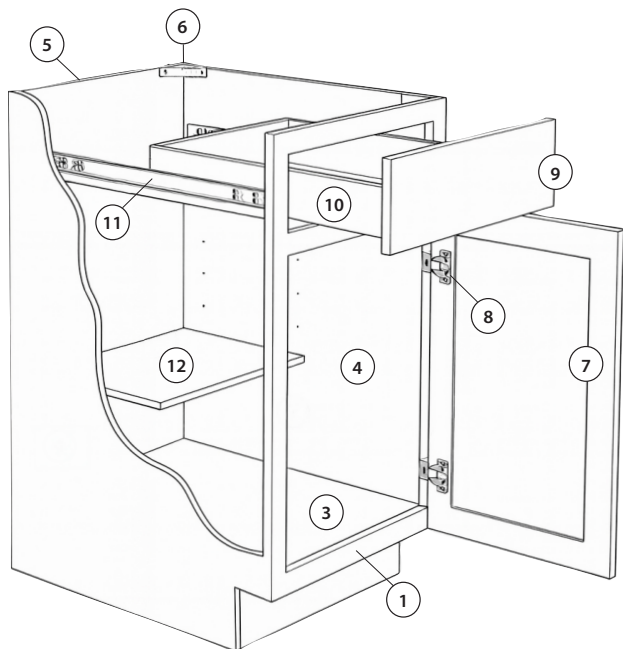

Available, ship or pickup locations:  
Charlotte, NC/Chicago, IL/Columbus, OH/  
Washington, DC

Lead time:

Ready-to-Assemble, 7-10 Business days

- 1 **Face Frame**  
- 3/4" solid wood.
- 2 **Wall Top & Floor Bottom**  
- 1/2" thick plywood.
- 3 **Base Bottom**  
- 1/2" thick plywood.
- 4 **End Panel**  
- 1/2" thick plywood.
- 5 **Back Panel**  
- 3/4" thick plywood.
- 6 **Corner Bracket**  
- Metal corner bracket adds extra reinforcement for base cabinetry.
- 7 **Door Panels, Full Overlay**  
- Solid birch door frame with MDF center panel.
- 8 **Hinges**  
- Integrated soft-close, 6-way adjustable, concealed European hinges.
- 9 **Drawer Fronts, Full Overlay**  
- 5-piece solid wood drawer front construction.
- 10 **Drawer Box Construction**  
- 5/8" thick solid wood sides with dovetail construction.
- 11 **Drawer Glides**  
- Full-extension soft-close, steel concealed undermount glides.
- 12 **Shelving**  
- 3/4" plywood adjustable shelving.

### Additional Notes

- Wood species: Solid birch or white oak face frames. All-plywood construction.
- Interior finish: UV-coated natural finish.
- Assembly options: Ready-to-assemble (RTA).
- Options available: Bathroom-depth vanities, glass door wall cabinets (glass included), cabinet inserts, trim and accessories.
- CARB 2 Compliant.
- ADA-compliant sizing available on select styles, restrictions may apply.



# JSI CABINETS

JSI Cabinetry delivers high-quality wood construction with rich details and attractive finishes. With a wide selection of styles and colors fit the latest in home décor trends, matching any design theme and lifestyle. The JSI Cabinetry mission is to deliver quality cabinetry that makes a high-end impression at a fraction of high-end cabinetry costs – allowing you to invest in additional upgrades and build the kitchen or bath of your dreams.

## JSI Ready-to-Assemble & Pre-Assembled Cabinets + Craftsmanship

### Inside JSI Cabinetry



JSI proudly offers rich details, attractive finishes and quality all-wood construction cabinets to fit any home or lifestyle.

### Carefully Selected Standard

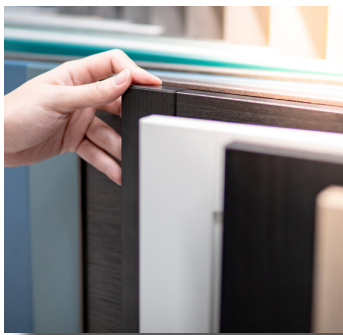

Each style collection is curated with finishes and designs that align with today's leading industry trends.

### Quality Craftsmanship



JSI Cabinets combine efficiency and durability, delivering lasting quality in both craftsmanship and design.

### Construction



Dovetail construction and soft-close hinges included in all styles of the Designer Series and Premier Collection.

### Finishing

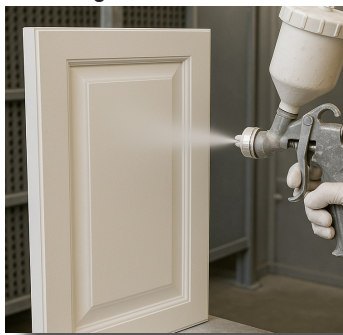

With factory-quality craftsmanship, JSI applies a catalyzed conversion varnish to painted cabinets and a polyurethane topcoat to stained cabinets, creating a long-lasting satin finish.

### Lead Times/Delivery



Shipping and pickup locations:

- Fall River, MA
- Bolingbrook, IL
- Atlanta, GA
- Denver, CO

Most orders ship within 1–2 weeks, based on if they are ready-to-assemble or fully assembled.



Essex, Norwich





*Putnam Rolling Ladders®,  
Classic No. 1 Ladder, Satin Brass,  
Quarter-Sawn White Oak*

*Dover Truffle*

# Door Styles & Colors



Trenton, Recessed

**Trenton** - Transitional style,  
Recessed top drawer, Ivory  
Paint

**Trenton** - Transitional style,  
Slab top drawer, Ivory Paint



**Yarmouth** - Traditional style,  
Raised top drawer,  
Soft-White Paint

**Yarmouth** - Transitional style,  
Slab top drawer,  
Soft-White Paint



Yarmouth, Raised

## Designer Series



**Essex** - Shaker style,  
Recessed top drawer

**CASTLE**  
Dark Gray Paint



**DRIFTWOOD**  
Light Beige Stain on Oak



**NORWICH**  
Light Gray Paint



**TRUFFLE**  
Light Brown Stain



**WHITE**  
White Paint



**Dover** - Flat panel recessed style,  
Slab top drawer

## Premier Series

**Amesbury White** -  
Shaker Style, Recessed or  
Slab top drawer option

**Amesbury Mist** -  
Shaker Style, Recessed or  
Slab top drawer option

**Upton Brown** -  
Shaker Style, Recessed or  
Slab top drawer option

**Recessed**

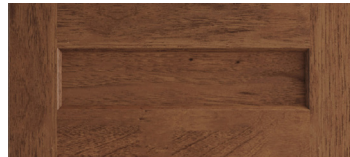

**Slab**

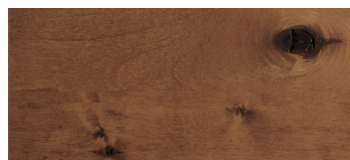
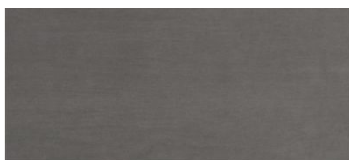

White Paint



Light Gray Stain



Rustic Brown Stain



*Upton, Brown*



*Dover, Truffle*



*Essex, Driftwood*



*Amesbury, Mist*

## Hoods Styles



**BX Beaded Hood**  
*Driftwood*



**CHW Hood**  
*Griege*



**ZO Hood**  
*Navy*



**T Hood**  
*Light Gray*



**ZE Hood**  
*Augusta*



**P Hood**  
*Charcoal*



**VCHIM Hood**  
*Sage*



**VRS Hood**  
*Dark Gray*

Hoods are available in all finishes shown on page 45 & 49. For details on available sizes, contact your CSH cabinetry expert.





Trenton & Nantucket Island, Greige

## Accent Island Door Styles & Colors



**Dover**



**Essex**

**AUGUSTA**  
Green Paint



**CHARCOAL**  
Soft-Black Paint



**DARK GRAY**  
Dark-Gray Paint



**GREIGE**  
Beige Paint



**LIGHT GRAY**  
Light-Gray Paint



**NAVY**  
Dark-Blue Paint



**Trenton Slab**



**Trenton Recessed**



**Yarmouth Slab**



**Yarmouth Raised**

**ROYAL**  
Bright-Blue Paint



**SAGE**  
Soft Green Paint



Note: Color as it appears in print will vary. For a more accurate view, please order a sample at [cshardware.com](http://cshardware.com)

# Inserts & Accessories

Utensil Tray Inserts & Tiered Cutlery Drawers



Charging Drawer System



Tiltout Tray



Soft-Close Roll-Out Tray



Blind Corner Organizer



*Because the inside matters just as much as the outside!*

Spice Pull-Out



Pan & Lid Organizer Pull-Out



Tray Divider



Vanity Pull-Out



Waste Pull-Out



Note: Accessory images are for reference only and may not reflect JSI Cabinetry door/finish options.

[More JSI](#)



## Cabinet Specifications

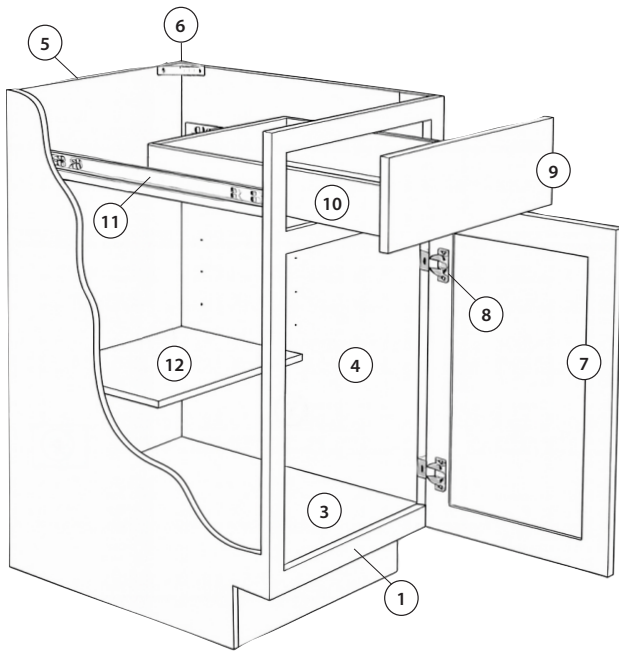
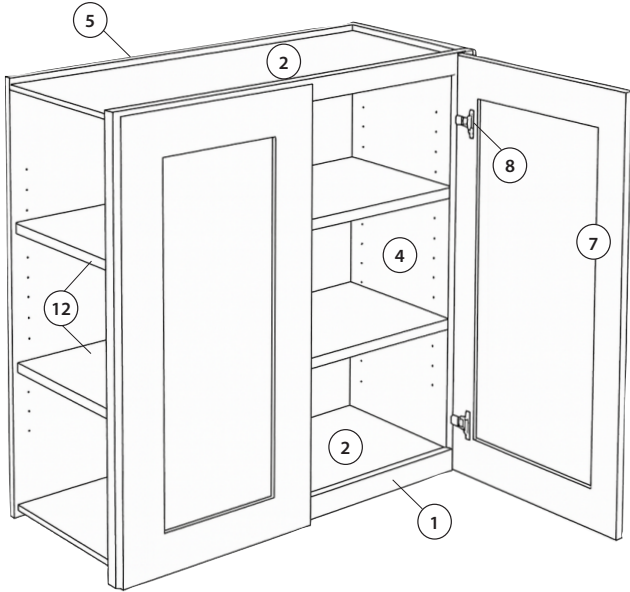

Designer/Premier/Trenton/Yarmouth





- 1 **Face Frame**  
- 3/4" solid wood x 1-1/2" wide.
- 2 **Wall Top & Floor Bottom**  
- 1/2" thick plywood.
- 3 **Base Bottom**  
- 3/8" thick plywood.
- 4 **End Panel**  
- 1/2" thick plywood; attaches to frame using half-dovetail joinery.
- 5 **Back Panel**  
- 1/2" thick solid plywood.
- 6 **Corner Bracket**  
- Adds extra stability (Designer Series: solid wood/Premier Series: plastic).
- 7 **Door Panels, Full Overlay**  
- Shaker, transitional & flat panel recessed styles. Maple or oak frame (depending on style), with 3/16" MDF center panel.  
- Raised panel (Yarmouth): maple frame, MDF center raised panel.

- 8 **Hinges**  
- Bremen integrated soft-close, 6-way adjustable, concealed cup hinge; BLUM upgrade available.
- 9 **Drawer Fronts, Full Overlay (Slab or Recessed)**  
- Slab or recessed 5-piece drawer front option in maple or oak (depending on style) with 3/16" MDF center panel.
- 10 **Drawer Box Construction**  
- 3/4" solid wood sides, dovetail construction.
- 11 **Drawer Glides**  
- Bremen full-extension, soft-close; BLUM upgrade available.
- 12 **Shelving**  
- 3/4" plywood adjustable shelving. (Designer Series)  
- 5/8" plywood adjustable shelving. (Premier Series)

### Additional Notes

- Wood species: Solid maple or oak face frames; all-plywood construction.
- Interior finish: Finished in natural maple.
- Assembly options: Ready-to-assemble (RTA) or Pre-assembled.
- Options available: Bathroom-depth vanities, wood & stainless steel hoods, cabinet inserts, trim, accessories and cabinet modifications.  
(modifications may add to your lead time)
-  CARB 2 Compliant.
-  ADA-compliant sizing available, on select styles.

 Available, ship or pickup locations:  
Atlanta, GA/Bolingbrook, IL/Denver, CO/  
Fall River, MA

 Lead time:  
Ready-to-Assemble, 1-3 Business days  
Pre-Assembled, 7-10 Business days

Legend Cabinetry offers a unique collection that blends innovative design with lasting quality. Crafted in the USA by experienced artisans, our cabinetry combines premium craftsmanship with affordable price points — delivering beauty, durability, and value for every home.

## Legend Pre-Assembled Cabinets + Craftsmanship

### Inside Legend Cabinetry

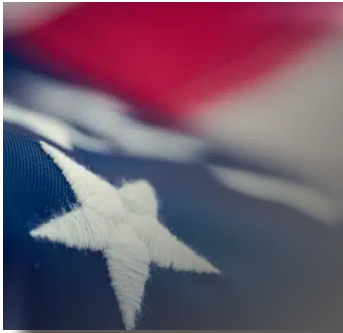

Welcome to Legend Cabinetry — proudly American-made with small-town roots. At Legend, you don't have to choose between quality and value — our craftsmanship brings tradition home.

### Carefully Selected Standard



Legend cabinetry begins with unique door designs to fit your style. Choose from high quality materials including Birch, Rustic Birch and HDF on painted styles — finished in today's most popular paint and stain colors.

### Quality Craftsmanship



Legend cabinets combine timeless design, quality craftsmanship, and lasting value. Legend is committed to delivering affordable cabinetry, built for today's lifestyles.

### Construction



Enjoy popular, high-end features — including plywood construction, concealed dovetail drawers with full extension, soft-close slides and hinges and more — all for an affordable price.

### Finishing

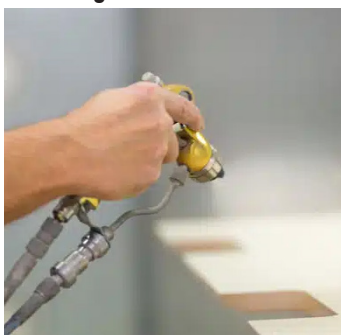

Put your trust in durable cabinetry featuring catalyzed varnish finishing baked on with infrared (IR) ovens in our state-of-the-art, environmentally controlled clean room free of dust, humidity and temperature fluctuations.

### Lead Times/Delivery



Shipping locations:

- Cottonwood, MN

Legend cabinets are made to order. Most ship within a 4 week timeframe.



Denali White & Rustic Acorn



*Putnam Rolling Ladders®,  
Quiet Glide® Ladder, Black, Maple*



*Pivot Ladder,  
Black, Maple*

# Door Styles & Colors

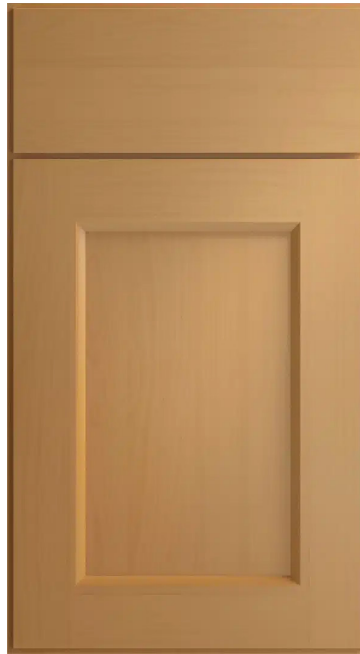

**\*Denali** - Transitional shaker style, Slab top drawer



**\*Niagra** - Transitional shaker style, Slab top drawer

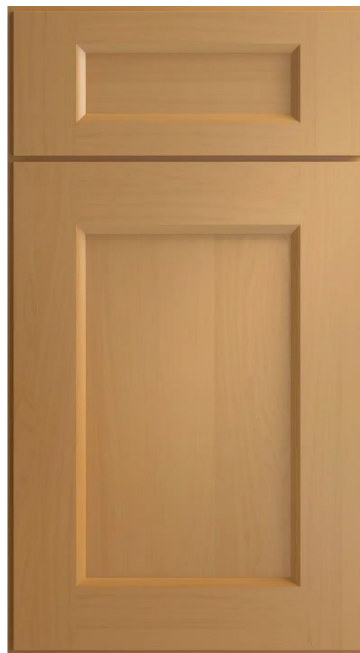

**\*Denali 5PC** - Transitional shaker style, Recessed top drawer



**\*Niagra 5PC** - Transitional shaker style, Recessed top drawer

**LEGEND**  
CABINETRY

MADE IN USA

Paint



ALOE

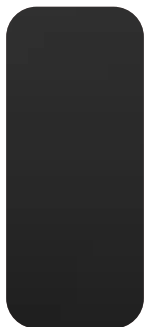

BLACK

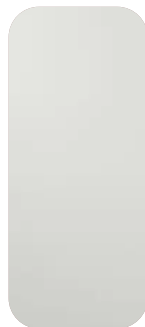

GLACIER



GRANITE



PEBBLE



SANDSTONE

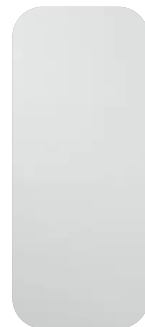

WHITE



**\*Rainier** - Flat panel shaker style, Slab top drawer

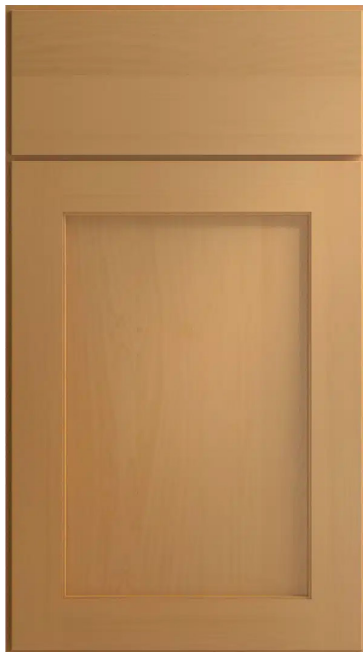

**\*Teton** - Transitional shaker style, Slab top drawer



**Sierra** - Modern shaker style, Slab top drawer

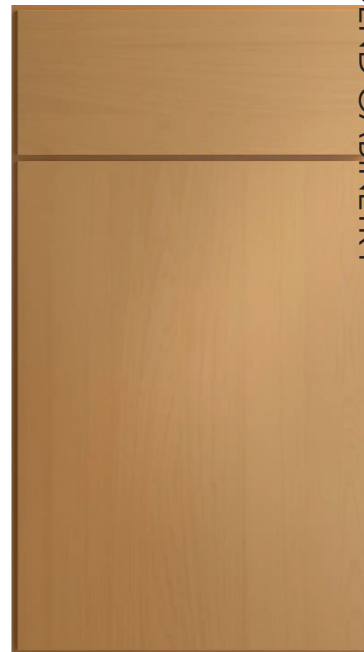

**Rushmore** - Contemporary style, Slab top drawer  
(Rushmore, not available in Nature)



**\*Rainier 5PC** - Flat panel shaker style, Recessed top drawer

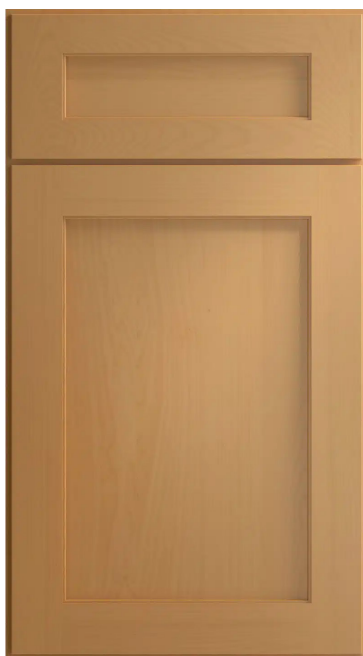

**\*Teton 5PC** - Transitional shaker style, Recessed top drawer



**Sierra 5PC** - Modern shaker style, Recessed top drawer

\*Also available in Rustic Birch. Natural variations in knots and graining make every piece unique.

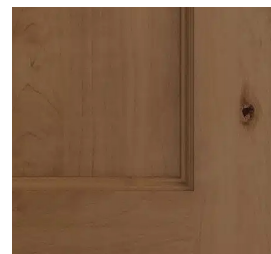

\*Niagra Rustic Acorn

Note: Color as it appears in print will vary. For a more accurate view, please order a sample at [cshardware.com](http://cshardware.com)

Birch Stains



ACORN



DRIFT



FLINT



HAZEL



MIST



NATURE



KODIAK



RUSTIC NATURAL



*Teton, Rustic Mist*



*Rainier, Aloe & Drift*



Rainier Pebble & Granite



Teton, Kodiak

# Inserts & Accessories

*Custom organization keeps everything in its place*

Cutlery Tray Insert



Wood Knife Block Insert



Wall Filler Pull-Out



Deluxe Corner Super Susan with Two Rotating Trays



Pull-Out Mini Pantry Base



Waste Pull-Out



Base Filler Pull-Out



Note: Accessory images are for reference only and may not reflect Legend Cabinetry door/finish options.

## Cabinet Specifications

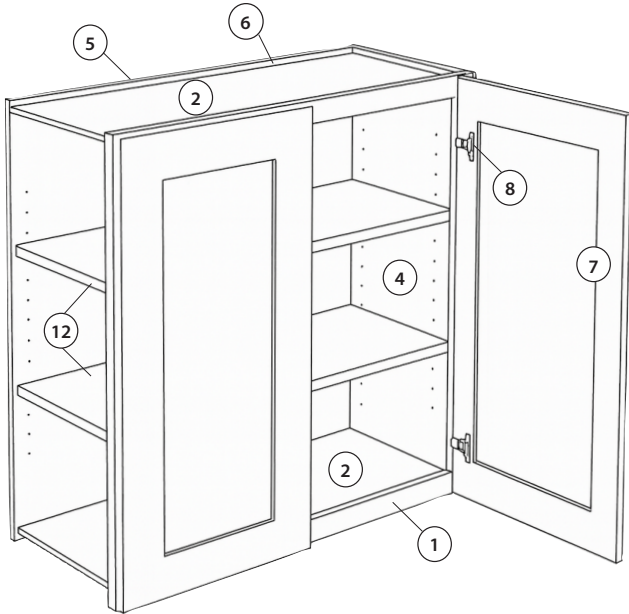

Exterior sides are unfinished and do not match the cabinet face. Specify finished ends for all exposed sides.

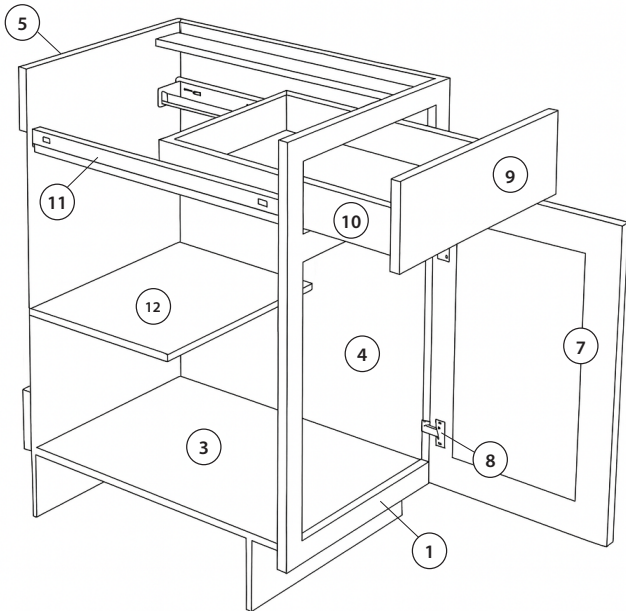

Available, ship locations:  
Cottonwood, MN

Lead time:  
Pre-Assembled, made to  
order - 4 Weeks

[More Legend](#)



- 1 **Face Frame**  
- 3/4" solid wood x 1-1/2" wide.
- 2 **Wall Top & Floor Bottom**  
- 1/2" thick plywood.
- 3 **Base Bottom**  
- 1/2" thick plywood.
- 4 **Side Panel**  
- 1/2" thick plywood, with natural birch interior;  
dovetailed into face frame.  
- Exterior sides are unfinished and do not match the  
cabinet face; specify finished ends for all exposed ends.
- 5 **Back Panel**  
- 1/4" thick full plywood back.
- 6 **Hang Rail**  
- 1/2" plywood hanging rail behind 1/4" back.
- 7 **Door Panels, Full Overlay**  
- Birch frame, with MDF center panel; recessed door.  
- 3/4" Birch veneer slab door (Rushmore style).  
- High Density Fiberboard (HDF) on painted styles.
- 8 **Hinges**  
- Soft-close, compact 6-way adjustable cup hinge.
- 9 **Drawer Fronts, Full Overlay (5 Piece or Slab Option)**  
- Birch frame, with MDF center panel; 5 piece drawer.  
- Solid birch slab drawer front.  
- 3/4" Birch veneer slab drawer front (Rushmore style).  
- High Density Fiberboard (HDF) on painted styles.
- 10 **Drawer Box Construction**  
- 5/8" birch veneer concealed dovetail drawer box.
- 11 **Drawer Glides**  
- Undermount full-extension, soft-close glides.
- 12 **Shelving**  
- 3/4" birch veneer plywood, adjustable shelving.

### Additional Notes

- Wood species: Birch & high-density fiberboard (HDF)  
on painted styles.
- Interior finish: Natural finish.
- Assembly options: Pre-assembled.
- Options available: Rustic birch available on select styles,  
bathroom-depth vanities, cabinet inserts, trim,  
accessories and cabinet modifications.  
(modifications may add to your lead time)
- CARB 2 Compliant.
- ADA-compliant sizing available, on select styles.
- Made in USA.

Open Air Outdoor Cabinetry is an American-made brand specializing in premium HDPE outdoor kitchen cabinets. Built to withstand the elements, our cabinets are durable, UV-stable, rust-free, easy to clean, and FDA-approved for food contact—bringing beauty, performance, and peace of mind to your outdoor space.

## Open Air Pre-Assembled Outdoor Cabinets + Craftsmanship

### Inside Open Air Cabinetry



Proudly made in America, the raw materials come from a local provider, and are made with 25% recycled plastic for an eco-friendly product. Open Air Outdoor Cabinetry materials are good for customers and the planet.

### Carefully Selected Standard



Open Air Outdoor Cabinetry features durable, weatherproof, and nontoxic materials built for any climate, with a wide range of colors and styles to elevate and transform your outdoor living space.

### Quality Craftsmanship



More than outdoor kitchen builders—we combine Pro Kitchens' software with advanced CNC machinery to craft cabinets with flawless finishes & custom styles. This process makes creating your dream outdoor space seamless.

### Construction



Open Air cabinetry crafts their cabinets from sustainable marine-grade polymers that are durable, moisture and stain-resistant, and FDA-approved for food contact. Stainless steel drawer slides and hinges are used to withstand the elements.

### Finishing



HDPE is a superior choice for maintenance and durability. The color of your choice is infused throughout the core of the material. Free from paints or VOCs, they're both safe & aesthetically pleasing.

### Lead Times/Delivery



Shipping locations:

- Olyphant, PA
- Open Air cabinets are made to order. Most ship within a 4-6 week timeframe.





*Woodgrain Dark Ash, Sanibel Shaker*



## Standard HDPE Door Styles

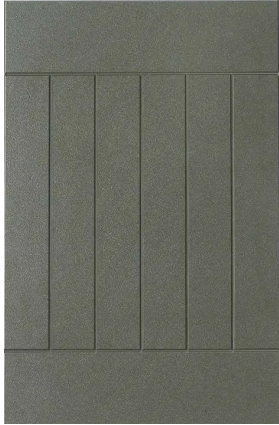

Cape Cod



Captiva Shaker

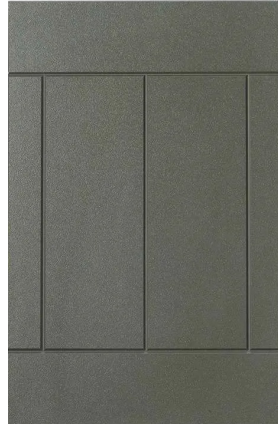

Country Living



Denver

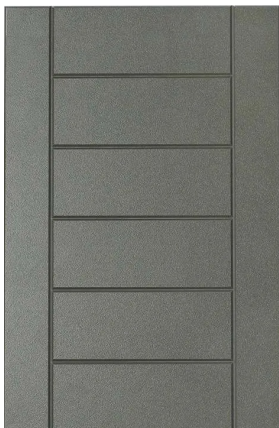

Napels



Riviera Maya

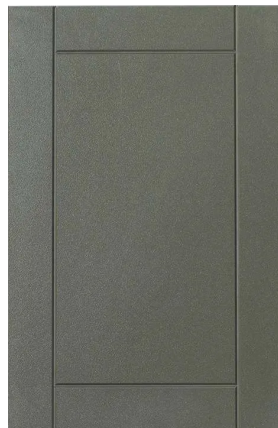

Sanibel Shaker

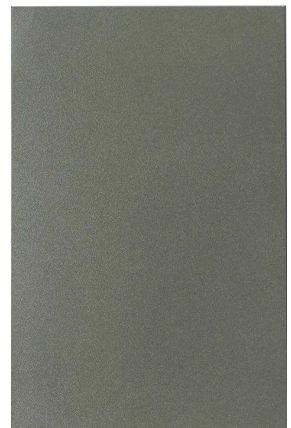

Simple

## Varigated Woodgrain Finishes

DARK ASH



NORTHEASTERN  
WALNUT



OLYPHANT OAK

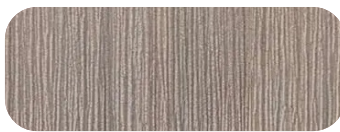

SUSQUEHANNA  
GREY

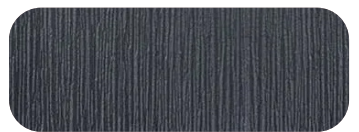

TEAK

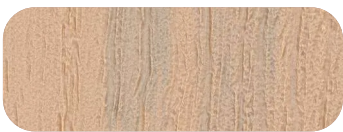

### Plain Finishes

BLACK

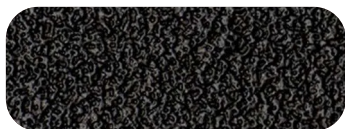

CHESTNUT

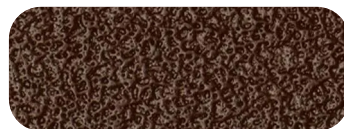

DESERT



DOLPHIN GREY



GLACIER GREY

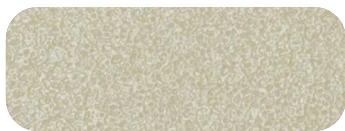

INDIGO

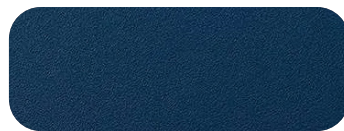

MOSS GREY



NUGGET

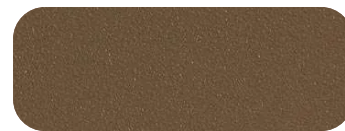

WHITE

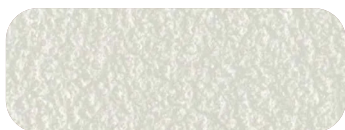

WROUGHT IRON

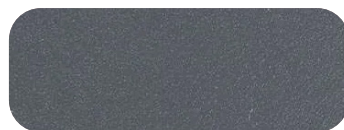

### Solid Woodgrain Finish

ELM

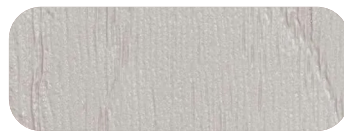

IRONWOOD

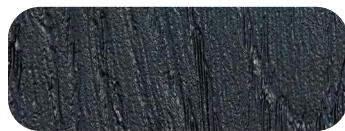

### Textured Finishes

NICKEL ROTARY BRUSHED



STAINLESS STEEL HAMMERED



STAINLESS STEEL ROTARY BRUSHED

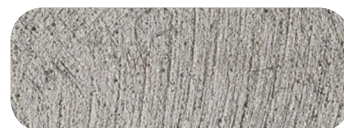



*Woodgrain Dark Ash, Sanibel Shaker*



*White, Simple*



*Moss Grey, Cape Cod*



*Elm, Sanibel Shaker*

# Inserts, Accessories & Customizations



## Grills

Design your perfect outdoor cooking space with a premium Blaze grill from Open Air.



## Beverage Center

Upgrade your outdoor space with a beverage center that delivers modern style and everyday convenience.



## Refrigerator

Keep refreshing drinks cool and right at hand with an outdoor fridge.



## Ice Maker

Conquer the heat and keep every drink ice-cold with an outdoor ice maker.

## Door Edge Profile Options

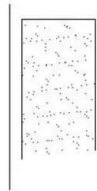

Square

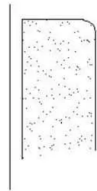

$\frac{1}{8}$ " Roundover



Small Ogee

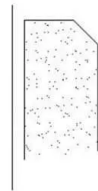

$\frac{1}{4}$ " Chamfer



## Cabinet Specifications

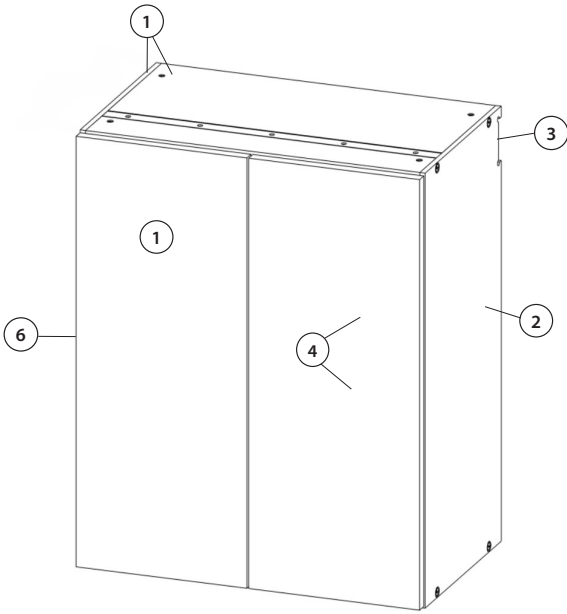

Assembly hardware will remain visible; order additional finished end panels for any exposed ends.

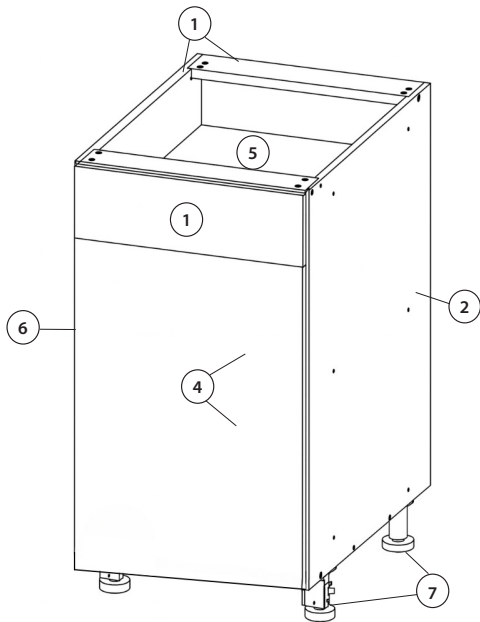

- ① **Cabinet Box, Door & Drawer Fronts**
  - Solid 3/4" thick polyethylene (HDPE) marine-grade polymer.
- ② **Side/Exterior End Panels**
  - Assembly hardware will remain visible on exposed ends. To conceal these areas, order an additional finished end panel. Choose a style that matches your cabinet doors, or select a plain panel for a clean, minimal look.
- ③ **Cleat/Wire Pass-Through**
  - This notch-out provides space for the mounting rail to allow flush installation, as well as a pass-through for cabinet lighting wires.
- ④ **Hinges**
  - Stainless steel.
- ⑤ **Drawer Box Construction & Glides**
  - Solid 1/2" thick polyethylene (HDPE) marine-grade polymer. Stainless steel, full-extension ball-bearing glides.
- ⑥ **Shelving**
  - Solid 3/4" thick polyethylene (HDPE) marine-grade polymer adjustable shelving.
- ⑦ **Leg Base**
  - Adjustable leveling legs for uneven surfaces. Includes mounting plate for optional toekick.

### Additional Notes

- HDPE materials: 100% recyclable high-density polyethylene with color running throughout. Maintenance-free, durable and backed by a limited lifetime warranty. FDA- and USDA-approved for food contact. Waterproof & resistant to mold, mildew, fungus, and bacteria. Superior UV-stabilization and fade-resistant.
- Aluminum rail runs along the top and bottom of wall cabinets, as well as the bottom of base cabinets and base cabinet shelving.
- Interior colors: Default to the color of cabinet (for matte finishes); black interiors available upon request subject to availability. Woodgrain and metallic colors will have the option of a matte finish.
- Cleaning: Clean with mild soap and water.
- Assembly options: Pre-assembled.
- Options available: Door edge profile options, cabinet inserts, trim and accessories.
- Sustainable and eco-friendly.
- Made in USA.

Available, shipping locations: Olyphant, PA

Lead time:  
Pre-Assembled, made to order. Most ship within a 4-6 week timeframe.

More Open Air

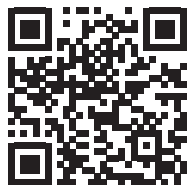

Since 1964, Conestoga Wood Specialties has crafted premium cabinet doors and wood components for the Kitchen & Bath industry. Family-owned and dedicated to quality, offering doors, moldings, drawer boxes, frames, RTA cabinets, and accessories. Conestoga production facilities are dedicated to serving individual market segments including Custom Kitchens, Baths and more.

## Conestoga Ready-to-Assemble Custom Cabinets + Craftsmanship

### Inside Conestoga Cabinetry



Through continuous refinement of our process and upgrading of equipment we combine the best that technology has to offer with over 1,100 trained and dedicated craftsmen, ensuring that our products will always meet or surpass our customers' expectations.

### Construction



The ready-to-assemble cabinet box offers solid wood dovetail drawer boxes, soft close drawer slides and hinges along with a number of optional enhancements.

### Carefully Selected Standard

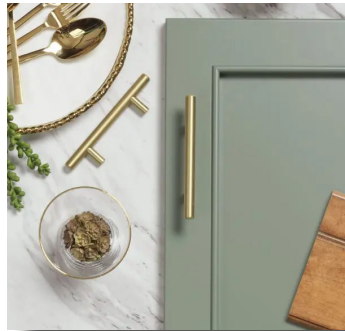

Conestoga has developed a variety of material grades to make the most of our natural resources while maintaining exceptional quality. Each grade offers distinct characteristics, giving you the flexibility to select the best option for your project needs.

### Finishing



Conestoga Wood Specialties leads the industry in finishes with over a thousand options to choose from. From painted effects to glazes and stains, every piece is crafted to preserve its beauty for a lifetime.

### Quality Craftsmanship



For over half a century, technology has advanced custom cabinetry, yet nothing matches the skill and passion of our craftspeople. With precise craftsmanship and a strong work ethic, we deliver products of lasting beauty and quality.

### Lead Times/Delivery



Shipping locations:

- East Pearl, PA
- Conestoga cabinets are made to order. Most ship within a 4 week time frame.



SavannahMT Door, Moody Blue





TW-10 Door, Slab Drawer Front,  
Frosty White & Ebony

## *Exceptional Craftsmanship*

High-quality, ready-to-assemble framed cabinet components are expertly crafted with sliding French dovetails and splines, ensuring both ease of assembly and years of durable use. This precision construction provides a strong foundation for a cabinetry program that is as versatile as it is dependable.

Building on that craftsmanship, the Cabinet Systems Program offers over 100 standard configurations and nearly limitless sizing options, giving you everything needed to design and build cabinetry for kitchens, baths, and beyond. From walls, bases, utilities, appliance cabinets, vanities, and specialty pieces, this expansive collection—enhanced by more than 100 door design choices and custom features such as mullions for glass doors, wood corbels, crown moldings, architectural accents, range hoods, inserts and pull-out organizers—allows you to meet virtually every design need.



*CRP-10 Door w/Reverse Panel,  
Cadet Grey & Arctic White*



*Pivot Ladder,  
Satin Brass, Red Oak*

*OmahaPP Door, Granite Peak*

## *Your Finish, Your Way*

The finishing touch is the first impression. That's why Conestoga Wood Specialties is dedicated to being leaders in the art of finish. From clean, timeless paints to glazes with depth and character, to stains that captivate the eye—the Conestoga craftsmanship is exceptional. With over a thousand options, plus fully custom creations, the possibilities are limited only by imagination. Every finish is carefully applied, whether by hand or with advanced technology, then sealed to ensure beauty that will last a lifetime.

*Choose from over 1,000 finish options*



# Farmhouse

Farmhouse cabinet doors feature a warm, inviting look with rustic details such as shaker-style panels, distressed finishes, or natural wood grains. They often incorporate light, neutral colors like white or cream to create a cozy, timeless, and welcoming kitchen atmosphere.



**Albany**



**CRP-10 Raised**

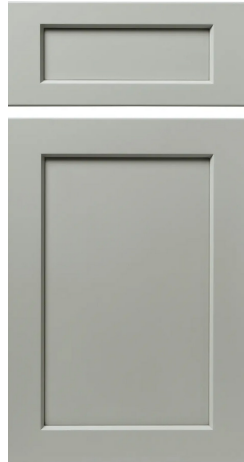

**CRP-10 Reversed**



**Madison**



**SavannahMT**



*Franklin Door,  
Dark Roast Stain On Cherry*



CRP-10 Reverse G-Cove, Frost Paint & Autumn Stain On Red Oak

## Traditional

Traditional style cabinets feature timeless design elements like raised panel doors, ornate molding, and rich wood finishes that create a warm and elegant look. They are often chosen for their classic appeal and ability to bring a sense of sophistication and tradition to kitchens and living spaces.



Crawford



CRP-101728



CRP-10875



CRP-10SQ2



Franklin

## Transitional

Transitional style cabinet doors blend the clean lines of contemporary design with the warmth and detailing of traditional cabinetry. They often feature simple frames and neutral finishes, making them versatile and timeless in both modern and classic kitchen spaces.



**Amesbury**



**Stockbridge**



**TW-Miter**



**TW-10**



**TW-1038**



*Rio Door-225,  
Allure Alternative Material, White Chocolate*



*TW-10 Door, Slab Drawer Front, Frosty White & Ebony*

## Modern

Contemporary cabinet doors emphasize sleek, clean lines with smooth surfaces and minimal ornamentation. They often use materials like glass, laminates, or wood veneers and pair well with neutral or bold finishes for a modern, streamlined look.



**Aspen**



**OmahaPP**

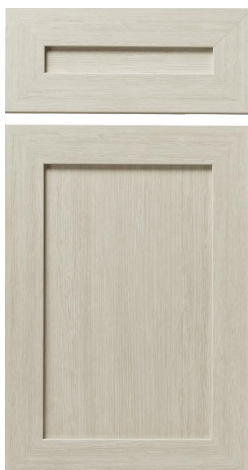

**Rio-225**

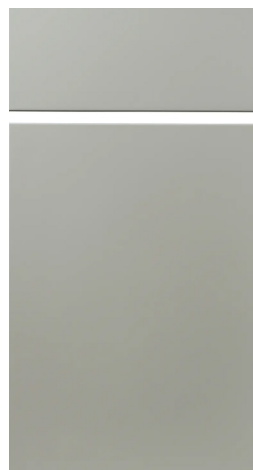

**Slab 1-Piece**

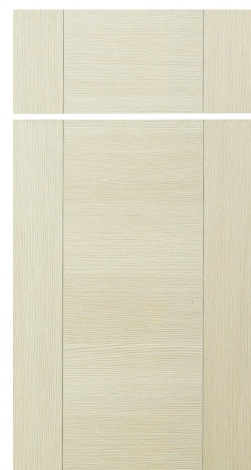

**Strata 3-Piece**

## Mullions

Simple or intricate, we offer a wide variety of mullion designs to choose from—or we can create one based on your own design. These doors are designed with grooves to accept glass, which you purchase separately from your local glass shop.



**6 Lite**



**9 Lite Offset**



**X-Lite with Open Hub**



**Double Bow**



**Continuous Double Arch**

## Hoods Styles

A range hood can be a focal point in a kitchen that merges form and function. It whisks steam and cooking grease out of a kitchen, helping to protect the cabinets and surfaces, and elevates the room's design. Conestoga has a wide selection of custom wood range hoods available, which can help you put the finishing touch on a new kitchen design.



**Z200, Driftwood Stain**



**CHW, Natural Stain**



**CSRH, Frosty White with Oyster Glaze**

## Decorative Elements

Adding a decorative post, corbel, or foot to your kitchen island brings depth and personality to the space. These details create a custom, furniture-style look that makes the island feel like a centerpiece rather than just a workspace, adding warmth and architectural charm to your kitchen design.

### End Posts



**Philmont**



**Townsend**



**Mission Plain**



**Waverly**

### Corbels



**CBL-LIN01**



**CBL-PN3**



**Chandler**



**Eaton**

### Furniture Style Feet



**Albion**



**Bailey**



**Cosmopolitan**



**Hillman**



**Metal Triframe**

### Crown Molding



**Crown 6**



**Crown 1529-A**



**Crown 24**



**Crown 1524**

# Inserts & Accessories



Base Organizer with Swivel Shelving



Paper Towel Holder Pull-Out



Beverage Pod Storage



Sliding Cutlery Drawer



Double Drawer Cookware Pull-Out



Pet Bowl Insert



Waste Pull-Out

Note: Accessory images are for reference only and may not reflect Conestoga Cabinetry door/finish options.

## Cabinet Specifications

### Advantage Framed Series

(Vesta Frameless Style Cabinets Available.  
Scan QR code below to learn more.)

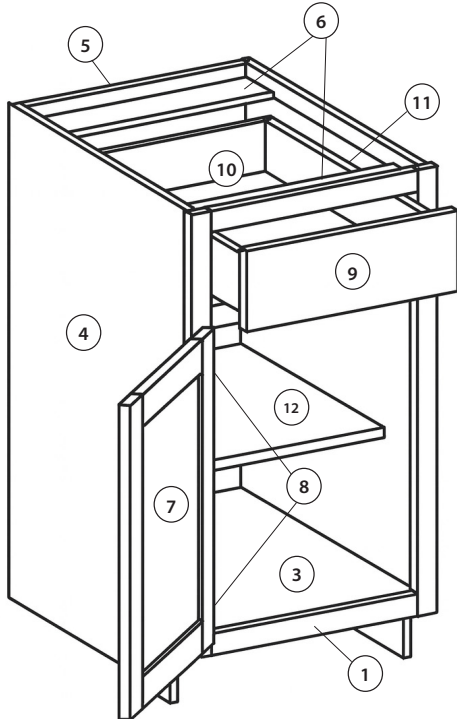
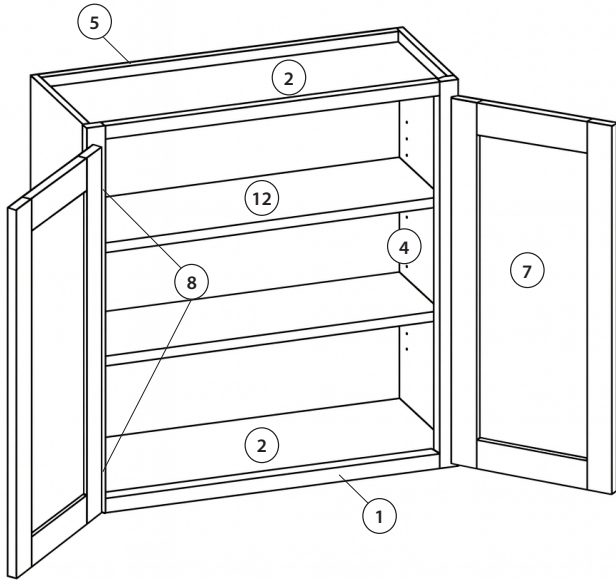

- ① **Front Frame**  
- 3/4" thick solid wood x 1-1/2" wide stiles and rails.
  - ② **Wall Top & Floor Bottom**  
- 1/2" thick plywood.
  - ③ **Base Bottom**  
- 1/2" thick plywood.
  - ④ **Side Panel**  
- 1/2" thick plywood.
  - ⑤ **Back Panel**  
- 1/2" thick plywood.
  - ⑥ **Front & Back Strip**  
- Most base cabinets include open tops with 1/2" thick x 3" deep plywood support strips running the full width of the front and back of the cabinet.
  - ⑦ **Door Panel Options**  
- Select from four standard overlay and inset door styles.  
- Select wood species of your choice.
  - ⑧ **Hinges**  
- BLUM hinges with integrated soft-close.
  - ⑨ **Drawer Front Options**  
- Select from four standard overlay and inset door styles.  
- Select wood species of your choice.
  - ⑩ **Drawer Box Construction**  
- English dovetail, 5/8" thick sides & back, 1/4" thick bottom.
  - ⑪ **Drawer Glides**  
- BLUM TANDEM Plus BLUMOTION integrated soft-close full-extension drawer glides.
  - ⑫ **Shelving**  
- 3/4" white birch plywood adjustable shelving.
- Additional Notes**
- Wood species options:  
Alder, cherry, hard maple, paint-grade hard maple, soft maple, hickory, red oak, white oak, walnut, white birch and more. (additional options available; consult your CSH cabinetry specialist).
  - Interior finish: Pre-finished or matching options.
  - Assembly options: Ready-to-assemble (RTA).
  - Options available: Hundreds of stain or paint colors, door styles, range hoods, valances, moldings, glass-ready doors, island posts, corbels, architectural accents, bathroom-depth vanities, cabinet inserts, accessories and cabinet modifications.  
(modifications may add to your lead time)
  - CARB 2 Compliant.
  - ADA-compliant sizing available on select styles.
  - Made in USA.

📍 Available, ship locations:  
East Pearl, PA

🚚 Lead time:  
Ready-to-Assemble,  
made to order - 4 Weeks

[More Conestoga](#)



## Customer Service Is Central To Our Mission



"Can't say enough good things about the quality of the cabinets. Our Cabinetry Expert went above and beyond. He kept in touch and walked me through keeping things straight as we were building multiple kitchens and baths once again. It was a pleasant experience from start to completion. I've used them for several properties and will definitely continue!" - *Kaz O.*

"Wonderful experience for each of the 3 projects I have purchased for with CS Hardware. First was for a beautiful walnut ladder and railing system... absolutely fantastic quality, second for a kitchen remodel that turned out beautifully + fantastic service and partnership during the ordering process (thank you to our Cabinetry Expert for your world-class service.), to our most recent office remodel. Great products and even better customer service. Well done Custom Service Hardware!! I will be your customer for life!!" - *Erica V.*

"I found CSH to be professional, well priced, with good communication back and forth as we designed, then redesigned a couple of more times. Our Cabinetry Expert provided excellent service. Highly recommended." - *Jeff K.*

"I have worked with CSH twice now. First was a full kitchen remodel, and the second we just added a dry bar to our new home. Our Cabinetry Expert listened to every detail and we got the whole thing done over the phone and emails. We couldn't be happier with the outcome." - *Katy F.*

"CSH and especially our Cabinetry Expert gave the kind of caring superb service that is totally nonexistent these days. I can't recommend them highly enough. Price, delivery, and quality of the JSI cabinets was first class." - *Chris W.*

"I was so happy with the level of personal customer attention extended by our Cabinetry Expert at CSH. She was friendly, helpful, and very responsive. I will definitely order from this company again." - *Jenny L.*

# Custom Service Hardware®

## *Policies, Shipping & Ordering*

### **Order Information**

Contact our knowledgeable cabinet sales team by phone, email, or text for personalized assistance with your order. Orders can also be placed online at [cshardware.com](http://cshardware.com).

\*All cabinet lines, colors, and pricing are subject to availability and change.

### **Order Changes**

If a change needs to be made to an order that has been finalized and placed, please contact your salesperson to discuss the options available. We cannot guarantee that any or all changes can be made, as submitted and confirmed orders are treated as final. Restock and/or cancellation fees may apply.

### **Returns**

Not all vendors accept returns. Please contact your salesperson to discuss return availability. For approved returns, return freight is the responsibility of the purchaser. Returns must be received at the originating warehouse in new, sellable, unassembled condition, in the original box, and will incur a vendor-specific restock fee. No returns can be authorized after 30 days. No returns can be made on items noted as Special Order, Made-to-Order, Semi-Custom, or Fully Assembled Cabinets.

### **Damage**

Freight Shipments must have a notation of "damage" for any damage claim to be considered. Any other comments such as "subject to inspection" are not acceptable. It is the purchaser's responsibility to sign the delivery receipt appropriately - not the delivery driver's. Do not install damaged or defective products. Assembly or modification of the products may void damage claims. CSH is not responsible for reimbursement of labor. To file a claim, please send an email to [service@cshardware.com](mailto:service@cshardware.com)

### **Contact Us**

We're excited to collaborate with you! Our team is ready to explore new possibilities, craft remarkable environments, and meet the distinct requirements of your projects, whether you're building, designing, or managing construction. Your trust matters to us, and we are committed to earning it through responsive service, industry-leading product, and a partnership designed to support your continued success. Let us help you create spaces that reflect your unique vision and elevate your reputation. Here's to the remarkable projects we'll create together, and to a partnership you can always depend on.

Custom Service Hardware  
cshardware.com  
800.882.0009



CUSTOM SERVICE HARDWARE®  
[www.cshardware.com](http://www.cshardware.com)  
800-882-0009  
[service@cshardware.com](mailto:service@cshardware.com)



PUTNAM ROLLING LADDER®  
is owned and operated by CSH  
[www.putnamrollingladder.com](http://www.putnamrollingladder.com)  
800-882-0009